

# 工业装配级套筒

**NORMECO SOCKETS & BITS**





工具改变生活  
品质成就未来

Tools Make Life Better, Quality Creates The Future.

# NORMECO INDUSTRIAL SOCKETS



我们于1997年成立企业，进入工业装配领域，2007年创立品牌NORMECO，开始工业级标准及非标准套筒生产。我们产品的应用领域：汽车、家电、航空、铁路、轨道交通、石化、重型机械、摩托车等制造及维修行业。

我们不断致力于产能、科研、产品质量的提升。

我们不断致力于全球行销和服务网络的建立与完善，以及时响应千里之外的客户需求。

发展至今，我们已获得国际、国内众多工业用户的一致认同和良好口碑。

NORMECO entered the assembly industry in 1997. 10 years later, in 2007, we established our own brand and began manufacturing NORMECO industrial tools. Our business has evolved from producing only standard bits and sockets to today where we now also design and manufacture all types of custom made items suited to our customer's unique specifications. The targeted industry: automotive, aerospace, appliances, electronics, industrial assembly, agriculture, off-road machinery, petrochemical industry, etc. Normeco is earning our brand awareness and reputation globally with our great product quality and service.



1/4"

P1-10

3/8"

P11-44

1/2"

P45-92

5/8"

P93-94

3/4"

P95-112

1"

P113-128

1-1/2"

P129-132

2-1/2"

P133-136

起子套筒

P137-145

起子头

P146-164



*We make industrial sockets*

## 工业装配级套筒制造

专业工具套筒:

诺麦柯工业级套筒是为专业工具所生产制造, 拥有最好的工业设计、材质、生产工艺及质量控制。  
生产工艺、材质:

诺麦柯工业级套筒为满足工业生产中专业人士或专业工具的要求, 采用高等级铬钼合金钢材制造 (Chrome-molybdenum alloy steel)。每一个套筒都是热锻压成型, 采用精密的CNC数控加工技术, 再经过标准的热处理和表面处理, 以确保其金属强度、刚度及表面耐磨性。

世界一流品质:

诺麦柯工业级套筒是依照美国标准(Federal Specifications GGG-W-660A)及德国标准(DIN 3121&3129)制造的世界一流产品。诺麦柯质量控制系统采用最新的技术与最精确的测量仪器对套筒的每一个测量点进行检测, 以保证每一个套筒的硬度、性能和扭矩都能达到国际标准。

品种众多, 规格齐全:

诺麦柯工业级套筒拥有所有常用规格的套筒系列, 包括: 1/4"、3/8"、1/2"、3/4"、1"、1-1/2"、2-1/2" 方孔, #5花键型孔套筒系列的常用英制规格、公制规格和星型规格。如果您所需要的套筒不在本目录中, 我们可以为您特别定制, 根据您的特殊规格说明、样品或图样进行生产。并保证其与我公司标准套筒有同样的品质。

NORMECO: Professional tool sockets.

NORMECO sockets, especially produced for professional industrial tools are the best in design, material, the production technique and quality control.

NORMECO: The top-ranking material, state-of-the-art production technique

NORMECO sockets are manufactured with Chrome-Molybdenum alloy steel to meet industrial professional personnel and special tools requirements.

Each sockets are forged forming by the standards of heat treatment and surface treatment, with sophisticated CNC machining technique so as to ensure its metal strength, stiffness and surface wear resistance

NORMECO: state-of-the-art quality

NORMECO sockets and accessories conform to Federal Specifications GGG-W-660A and DIN 3121&3129.

Our independent quality control system with the latest technology and the most accurate measuring instrument ensures that each socket hardness, performance and torque is able to meet international standards with the best properties and a longer service life.

NORMECO: varieties sockets and complete specifications

NORMECO sockets are consists of 1/4" ,3/8" ,1/2" ,3/4" , 1" , 1-1/2" and 2-1/2" square drive" , #5 spline SAE size, metric size and torx sockets. We design and produce special sockets to meet the individual requirements of every single customer. We are also proud to be able to offer our custom-designed sockets. We handle everything from product development and design to manufacturing hand tool testing.



## 工业装配级套筒 INDUSTRIAL SOCKETS



警告 WARNING

使用时请穿戴好保护身体各部位的相应防护用品，严禁在没有任何保护的情况下使用。  
Always wear safety goggles when using impact tools. Do not hold socket while in use.

本目录中的所有参数如有变动，恕不另行通知，本公司保留对样本进行修改的权利。

Product improvement is continuing. Designs and specifications are changing without prior notice.  
The company reserves the right to modify the catalogue.

1/4"

P1-10

3/8"

P11-44

1/2"

P45-92

5/8"

P93-94

3/4"

P95-112

1"

P113-128

1-1/2"

P129-132

2-1/2"

P133-136

起子套筒

P137-145

起子头

P146-164



# NORMECO INDUSTRIAL SOCKETS

- 1/4"
- P1-10
- 3/8"
- P11-44
- 1/2"
- P45-92
- 5/8"
- P93-94
- 3/4"
- P95-112
- 1"
- P113-128
- 1-1/2"
- P129-132
- 2-1/2"
- P133-136
- 起子套筒
- P137-145
- 起子头
- P146-164

## 六角标准套筒 6-Point Sockets

1/4" Square Drive 6-Point Sockets

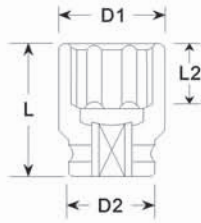

Order No.	Size mm	D2 mm	D1 mm	L2 mm	L mm
80102040	4	13	7.6	4	23
80102045	4.5	13	8.2	5	23
80102050	5	13	8.8	5	23
80102055	5.5	13	9.5	5	23
80102060	6	13	10	6	23
80102070	7	13	11.3	6	23
80102080	8	13	12.5	7	23
80102090	9	13	13.8	7	23
80102100	10	13	15	7	23
80102110	11	13	16.3	8	23
80102120	12	13	17	8	23
80102130	13	13	18.8	8	23
80102140	14	13	20	8	23
80102150	15	13	21	8	23

Order No.	Size Inch	D2 mm	D1 mm	L2 mm	L mm
80102560	3/16"	13	8.5	5	23
80102570	7/32"	13	9.5	5	23
80102580	1/4"	13	10.3	6	23
80102590	9/32"	13	11.3	6	23
80102600	5/16"	13	12.5	7	23
80102610	11/32"	13	13.8	7	23
80102620	3/8"	13	15	7	23
80102640	7/16"	13	16.3	8	23
80102660	1/2"	13	18.8	8	23
80102680	9/16"	13	20	8	23

## 六角加长套筒 6-Point Sockets-Deep length

1/4" Square Drive 6-Point Sockets

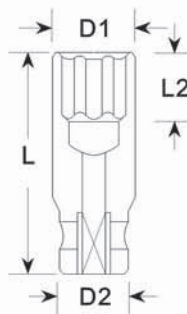

Order No.	Size mm	D2 mm	D1 mm	L2 mm	L mm
80104040	4	13	7.6	4	50
80104045	4.5	13	8.2	6	50
80104050	5	13	8.8	6	50
80104055	5.5	13	9.5	6	50
80104060	6	13	10	6	50
80104070	7	13	11.3	7	50
80104080	8	13	12.5	9	50
80104090	9	13	13.8	9	50
80104100	10	13	15	9	50
80104110	11	13	16.3	9	50
80104120	12	13	17	9	50
80104130	13	13	18.8	9	50
80104140	14	13	20	9	50
80104150	15	13	21	9	50

Order No.	Size Inch	D2 mm	D1 mm	L2 mm	L mm
80104560	3/16"	13	8.5	5	50
80104570	7/32"	13	9.5	6	50
80104580	1/4"	13	10.3	6	50
80104590	9/32"	13	11.3	7	50
80104600	5/16"	13	12.5	9	50
80104610	11/32"	13	13.8	9	50
80104620	3/8"	13	15	9	50
80104640	7/16"	13	16.3	9	50
80104660	1/2"	13	18.8	9	50
80104680	9/16"	13	20	9	50



## 六角固定磁标准套筒 6-Point Sockets-With Fixed Magnet

1/4" Square Drive 6-Point Sockets

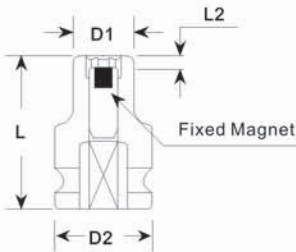

Order No.	Size mm	D2 mm	D1 mm	L2 mm	L mm
80260106	6	13	10	3	23
80260107	7	13	11.5	3	23
80260108	8	13	12.5	3.5	23
80260109	9	13	14	4	23
80260110	10	13	15	4	23
80260111	11	13	16	5	23
80260112	12	13	17	5	23
80260113	13	13	19	5	23
80260114	14	13	20	6	23
80260115	15	13	21	6	23

Order No.	Size inch	D2 mm	D1 mm	L2 mm	L mm
80260008	1/4"	13	10.5	3	23
80260010	5/16"	13	12.5	3	23
80260012	3/8"	13	15	4	23
80260014	7/16"	13	16.3	5	23
80260016	1/2"	13	18.8	5	23
80260018	9/16"	13	20	6	23

## 六角伸缩磁加长套筒 6-Point Sockets-With Sliding Magnet

1/4" Square Drive 6-Point Sockets

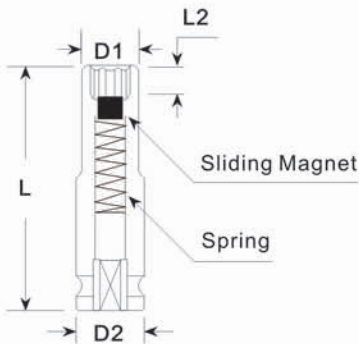

Order No.	Size mm	D2 mm	D1 mm	L2 mm	L mm
80260306	6	13	10	3	50
80260307	7	13	11.5	3	50
80260308	8	13	12.5	3.5	50
80260309	9	13	14	4	50
80260310	10	13	15	4	50
80260311	11	13	16	5	50
80260312	12	13	17	5	50
80260313	13	13	19	5	50
80260314	14	13	20	6	50
80260315	15	13	21	6	50

Order No.	Size inch	D2 mm	D1 mm	L2 mm	L mm
80260208	1/4"	13	10.5	3	50
80260210	5/16"	13	12.5	3	50
80260212	3/8"	13	15	4	50
80260214	7/16"	13	16.3	5	50
80260216	1/2"	13	18.8	5	50
80260218	9/16"	13	20	6	50

1/4"

P1-10

3/8"

P11-44

1/2"

P45-92

5/8"

P93-94

3/4"

P95-112

1"

P113-128

1-1/2"

P129-132

2-1/2"

P133-136

起子套筒

P137-145

起子头

P146-164



# NORMECO INDUSTRIAL SOCKETS

1/4"
P1-10
3/8"
P11-44
1/2"
P45-92
5/8"
P93-94
3/4"
P95-112
1"
P113-128
1-1/2"
P129-132
2-1/2"
P133-136
起子套筒
P137-145
起子头
P146-164

## 旋护套筒 Standard Sockets With Rotating Cover

1/4" Square Drive

Rotating Cover  
Flat Rotating Cover

6-Point Sockets  
六角套筒

6-Point Surface Drive Sockets  
大圆弧套筒

External Torx Sockets  
外星型套筒

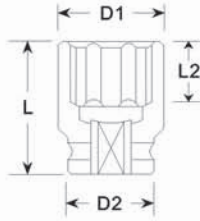

Socket

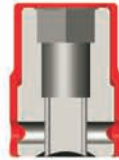

Rotating Cover  
端面防护型

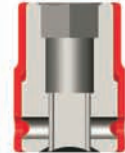

Flat Rotating Cover  
端面齐平型



诺麦柯旋护套筒实现套筒在护套内的自由旋转，从而减少或消除紧固作业中人与旋转部件的接触，除了提高操作人员安全性，同时也有助于最大限度地减少系统损坏和紧固过程中造成的碰撞。Normeco rotating cover is designed to enable the impact socket spinning freely inside the cover, which significantly reducing or even eliminating the access between operators and rotating parts during tightening. It improves safety, and helps to minimize the risk of system damage and marring work pieces during fastening operation.

Order No.	Size mm	D2 mm	D1 mm	L2 mm	L mm
No. + RC	-	-	-	-	-
No. + FRC	-	-	-	-	-

## 六角万向标准套筒 6-Point Universal Sockets

1/4" Square Drive

6-Point Universal

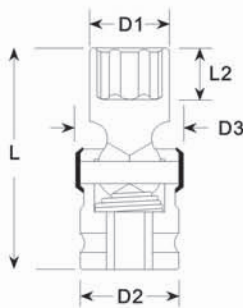

Order No.	Size mm	D3 mm	D2 mm	D1 mm	L2 mm	L mm
80348006	6	20	15	10	6	43
80348007	7	20	15	11.5	8	43
80348008	8	20	15	12.5	8	43
80348010	10	20	15	15	8	43
80348012	12	20	16	17	8	48
80348013	13	20	16	19	8	48
80348014	14	20	16	20	8	48
80348015	15	20	16	21	8	48

Order No.	Size inch	D3 mm	D2 mm	D1 mm	L2 mm	L mm
80348508	1/4"	20	15	10	6	43
80348510	5/16"	20	15	12.5	8	43
80348512	3/8"	20	15	15	8	43
80348514	7/16"	20	16	16.5	8	43
80348516	1/2"	20	16	19	8	48
80348518	9/16"	20	16	20	8	48



## 标准大圆弧套筒 6-Point Surface Drive Sockets

1/4" Square Drive 6-Point Surface Drive Sockets

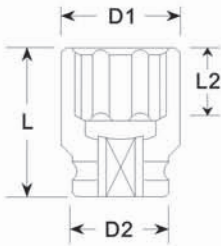

Order No.	Size mm	D2 mm	D1 mm	L2 mm	L mm
80465004	4	13	7.6	4	23
804650045	4.5	13	8.2	5	23
80465005	5	13	8.8	5	23
804650055	5.5	13	9.5	5	23
80465006	6	13	10	6	23
80465007	7	13	11.3	6	23
80465008	8	13	12.5	7	23
80465009	9	13	13.8	7	23
80465010	10	13	15	7	23
80465011	11	13	16.3	8	23
80465012	12	13	17	8	23
80465013	13	13	18.8	8	23
80465014	14	13	20	8	23
80465015	15	13	21	8	23

Order No.	Size inch	D2 mm	D1 mm	L2 mm	L mm
80465058	1/4"	13	10.3	6	23
80465060	5/16"	13	12.5	7	23
80465062	3/8"	13	15	7	23
80465064	7/16"	13	16.3	8	23
80465066	1/2"	13	18.8	8	23
80465068	9/16"	13	20	8	23

## 大圆弧加长套筒 6-Point Surface Drive Sockets-Deep

1/4" Square Drive 6-Point Surface Drive Sockets-Deep

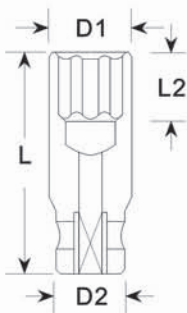

Order No.	Size mm	D2 mm	D1 mm	L2 mm	L mm
80465104	4	13	7.6	4	50
804651045	4.5	13	8.2	6	50
80465105	5	13	8.8	6	50
804651055	5.5	13	9.5	6	50
80465106	6	13	10	7	50
80465107	7	13	11.3	7	50
80465108	8	13	12.5	9	50
80465109	9	13	13.8	9	50
80465110	10	13	15	9	50
80465111	11	13	16.3	9	50
80465112	12	13	17	9	50
80465113	13	13	18.8	9	50
80465114	14	13	20	9	50
80465115	15	13	21	9	50

Order No.	Size inch	D2 mm	D1 mm	L2 mm	L mm
80465158	1/4"	13	10.3	7	50
80465160	5/16"	13	12.5	9	50
80465162	3/8"	13	15	9	50
80465164	7/16"	13	16.3	9	50
80465166	1/2"	13	18.8	9	50
80465168	9/16"	13	20	9	50

1/4"

P1-10

3/8"

P11-44

1/2"

P45-92

5/8"

P93-94

3/4"

P95-112

1"

P113-128

1-1/2"

P129-132

2-1/2"

P133-136

起子套筒

P137-145

起子头

P146-164



# NORMECO INDUSTRIAL SOCKETS

- 1/4"
- P1-10
- 3/8"
- P11-44
- 1/2"
- P45-92
- 5/8"
- P93-94
- 3/4"
- P95-112
- 1"
- P113-128
- 1-1/2"
- P129-132
- 2-1/2"
- P133-136
- 起子套筒
- P137-145
- 起子头
- P146-164

## ▶ 大圆弧固定磁标准套筒 Surface Drive Sockets-With Fixed Magnet

- 1/4" Square Drive
- 6-Point Surface Drive Sockets

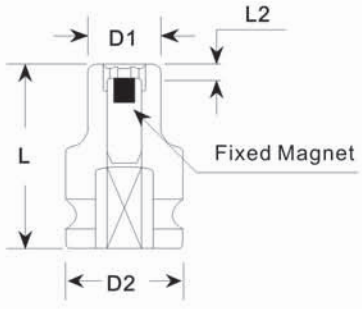

Order No.	Size mm	D2 mm	D1 mm	L2 mm	L mm
80284106	6	13	10	3	23
80284107	7	13	11.5	3	23
80284108	8	13	12.5	3.5	23
80284109	9	13	14	4	23
80284110	10	13	15	4	23
80284111	11	13	16	5	23
80284112	12	13	17	5	23
80284113	13	13	19	5	23
80284114	14	13	20	6	23
80284115	15	13	21	6	23

Order No.	Size inch	D2 mm	D1 mm	L2 mm	L mm
80284008	1/4"	13	10.5	3	23
80284010	5/16"	13	12.5	3	23
80284012	3/8"	13	15	4	23
80284014	7/16"	13	16.3	5	23
80284016	1/2"	13	18.8	5	23
80284018	9/16"	13	20	6	23

## ▶ 大圆弧伸缩磁加长套筒 Surface Drive Sockets-Deep With Sliding Magnet

- 1/4" Square Drive
- 6-Point Surface Drive Sockets-Deep With Sliding Magnet

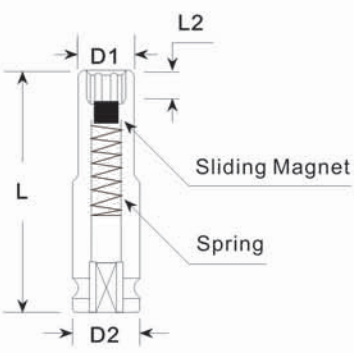

Order No.	Size mm	D2 mm	D1 mm	L2 mm	L mm
80284306	6	13	10	3	50
80284307	7	13	11.5	3	50
80284308	8	13	12.5	3.5	50
80284309	9	13	14	4	50
80284310	10	13	15	4	50
80284311	11	13	16	5	50
80284312	12	13	17	5	50
80284313	13	13	19	5	50
80284314	14	13	20	6	50
80284315	15	13	21	6	50

Order No.	Size inch	D2 mm	D1 mm	L2 mm	L mm
80284208	1/4"	13	10.5	3	50
80284210	5/16"	13	12.5	3	50
80284212	3/8"	13	15	4	50
80284214	7/16"	13	16.3	5	50
80284216	1/2"	13	18.8	5	50
80284218	9/16"	13	20	6	50



## ▶ 外星型标准套筒 External Torx Sockets

1/4" Square Drive External Torx Sockets

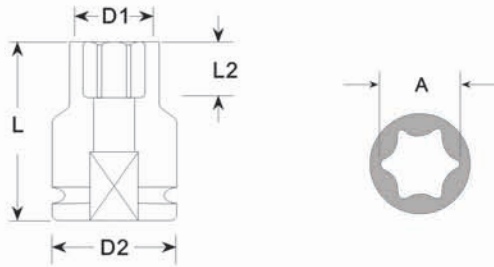

Order No.	Star	A mm	D2 mm	D1 mm	L2 mm	L mm
80174305	E5	4.72	13	8	4.5	25
80174306	E6	5.69	13	9	5	25
80174307	E7	6.17	13	9.5	6	25
80174308	E8	7.47	13	10	6	25
80174310	E10	9.37	13	12.5	7.5	25
80174312	E12	11.12	14.5	14.5	8.5	25

## ▶ 外星型薄壁套筒 External Torx Sockets-Thin Wall

1/4" Square Drive External Torx Sockets-Thin Wall

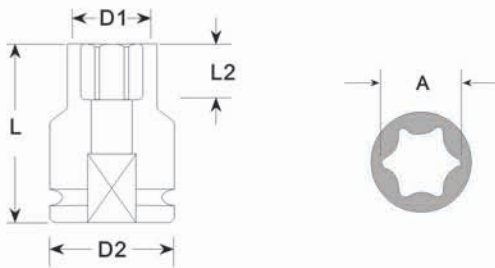

Order No.	Star	A mm	D2 mm	D1 mm	L2 mm	L mm
80174505	E5	4.72	13	7	4.5	25
80174506	E6	5.69	13	8	5	25
80174507	E7	6.17	13	8.5	6	25
80174508	E8	7.47	13	9	6	25
80174510	E10	9.37	13	11.5	7.5	25
80174512	E12	11.12	14.5	13.5	8.5	25

## ▶ 外星型加长套筒 External Torx Sockets-Deep

1/4" Square Drive External Torx Sockets-Deep

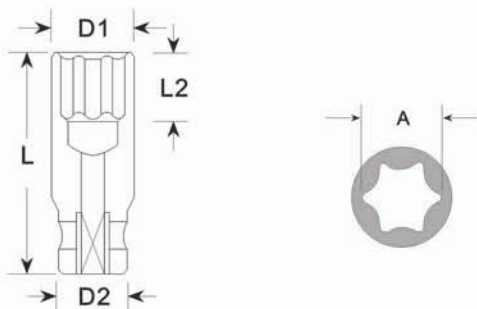

Order No.	Star	A mm	D2 mm	D1 mm	L2 mm	L mm
80174705	E5	4.72	13	8	4.5	50
80174706	E6	5.69	13	9	5	50
80174707	E7	6.17	13	9.5	6	50
80174708	E8	7.47	13	10	6	50
80174710	E10	9.37	13	12.5	7.5	50
80174712	E12	11.12	14.5	14.5	8.5	50

1/4"  
P1-10  
3/8"  
P11-44  
1/2"  
P45-92  
5/8"  
P93-94  
3/4"  
P95-112  
1"  
P113-128  
1-1/2"  
P129-132  
2-1/2"  
P133-136  
起子套筒  
P137-145  
起子头  
P146-164



# NORMECO INDUSTRIAL SOCKETS

- 1/4"
- P1-10
- 3/8"
- P11-44
- 1/2"
- P45-92
- 5/8"
- P93-94
- 3/4"
- P95-112
- 1"
- P113-128
- 1-1/2"
- P129-132
- 2-1/2"
- P133-136
- 起子套筒
- P137-145
- 起子头
- P146-164

## 内六角套筒 Male Hex Drive Sockets

1/4" Square Drive Male Hex Drive Sockets

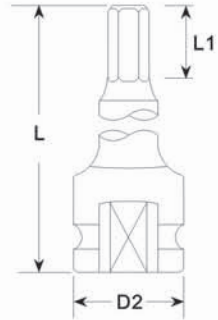

Order No.	Size mm	D2 mm	L1 mm	L mm
80509303	3	13	4.5	35
80509304	4	13	6	35
80509305	5	13	6	35
80509306	6	13	6	35
80509307	7	13	8	35
80509308	8	13	8	35
80509309	9	13	10	35
80509310	10	13	10	35

Order No.	Size inch	D2 mm	L1 mm	L mm
80509204	1/8"	13	6	35
80509205	5/32"	13	6	35
80509206	3/16"	13	6	35
80509207	7/32"	13	6	35
80509208	1/4"	13	6	35
80509209	9/32"	13	8	35
80509210	5/16"	13	8	35
80509212	3/8"	13	10	35

## 内星型套筒 Internal Torx Sockets

1/4" Square Drive Internal Torx Sockets

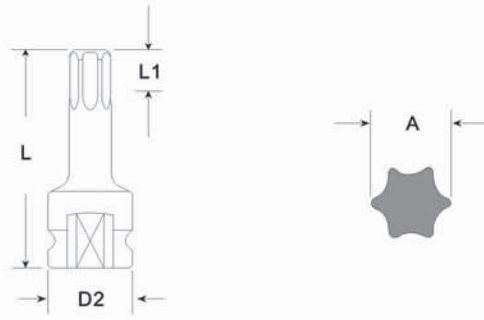

Order No.	Size	A mm	D2 mm	L1 mm	L mm
80171310	T10	2.72	13	3	35
80171315	T15	3.26	13	3	35
80171320	T20	3.84	13	3	35
80171325	T25	4.40	13	3	35
80171327	T27	4.96	13	3	35
80171330	T30	5.50	13	3.5	35



## ▶ 旋护内方套筒 Internal Sockets With Rotating Cover

1/4" Square Drive

Hex Sockets  
内六角套筒

Internal Torx Sockets  
内星型套筒

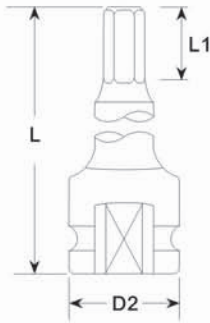

诺麦柯旋护套筒实现套筒在护套内的自由旋转，从而减少或消除紧固作业中人与旋转部件的接触，除了提高操作人员安全性，同时也有助于最大限度地减少系统损坏和紧固过程中造成的碰撞。  
Normeco rotating cover is designed to enable the impact socket spinning freely inside the cover, which significantly reducing or even eliminating the access between operators and rotating parts during tightening. It improves safety, and help to minimize the risk of system damage and marring work pieces during fastening operation.

## ▶ 万向接头 Universal Joints

1/4" Square Drive

Universal Joints

Order No.	1/4" Inch	3/8" Inch	D2 mm	L mm	Male End Type
80668503	1/4"	1/4"	16	40	Steel Ball
80668504	1/4"	1/4"	16	40	Pin Hole
80668505	1/4"	1/4"	16	40	Lock Pin

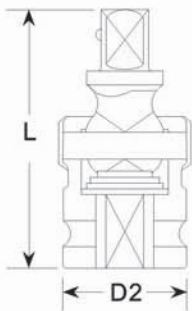

Steel Ball  
钢珠式



Lock Pin  
锁销式



Pin Hole  
销孔式



## ▶ 气动转换头 Adapter

1/4" Square Drive

Adapter

Order No.	1/4" Inch	3/8" Inch	D2 mm	L mm	Male End Type
80662010	1/4"	3/8"	13.6	26	Steel Ball
80662015	1/4"	3/8"	13.6	26	Lock Pin
80662020	1/4"	3/8"	13.6	26	Pin Hole

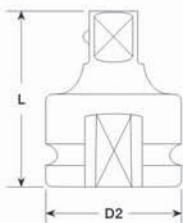

Steel Ball  
钢珠式



Lock Pin  
锁销式



Pin Hole  
销孔式



1/4"	P1-10
3/8"	P11-44
1/2"	P45-92
5/8"	P93-94
3/4"	P95-112
1"	P113-128
1-1/2"	P129-132
2-1/2"	P133-136
套筒	P137-145
套筒头	P146-164



# NORMECO INDUSTRIAL SOCKETS

- 1/4"
- P1-10
- 3/8"
- P11-44
- 1/2"
- P45-92
- 5/8"
- P93-94
- 3/4"
- P95-112
- 1"
- P113-128
- 1-1/2"
- P129-132
- 2-1/2"
- P133-136
- 起子套筒
- P137-145
- 起子头
- P146-164

## 延长杆 Extension Bars

1/4" Square Drive Extension Bars

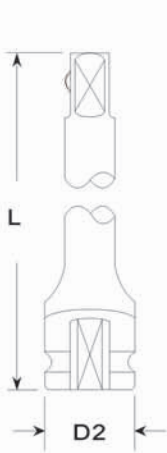

Steel Ball  
钢珠式



Lock Pin  
锁销式



Pin Hole  
销孔式



Order No.	D2 mm	L mm	Male End Type
80612050	13	50	Steel Ball
80612075	13	75	Steel Ball
80612100	13	100	Steel Ball
80612125	13	125	Steel Ball
80612150	13	150	Steel Ball
80612175	13	175	Steel Ball
80612200	13	200	Steel Ball
80612250	13	250	Steel Ball

Order No.	D2 mm	L mm	Male End Type
80613050	13	50	Lock Pin
80613075	13	75	Lock Pin
80613100	13	100	Lock Pin
80613125	13	125	Lock Pin
80613150	13	150	Lock Pin
80613175	13	175	Lock Pin
80613200	13	200	Lock Pin
80613250	13	250	Lock Pin

Order No.	D2 mm	L mm	Male End Type
80615050	13	50	Pin Hole
80615075	13	75	Pin Hole
80615100	13	100	Pin Hole
80615125	13	125	Pin Hole
80615150	13	150	Pin Hole
80615175	13	175	Pin Hole
80615200	13	200	Pin Hole
80615250	13	250	Pin Hole

## 旋护延长杆 Extension Bars With Rotating Cover

1/4" Square Drive Extension Bars

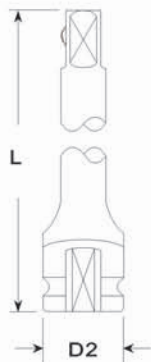

Steel Ball  
钢珠式



Lock Pin  
锁销式



Order No.	D2 mm	L mm	Male End Type
No. +RC	-	-	Steel Ball
No. +RC	-	-	Lock Pin



▶ NORMECO套筒应用

Special Parts Application

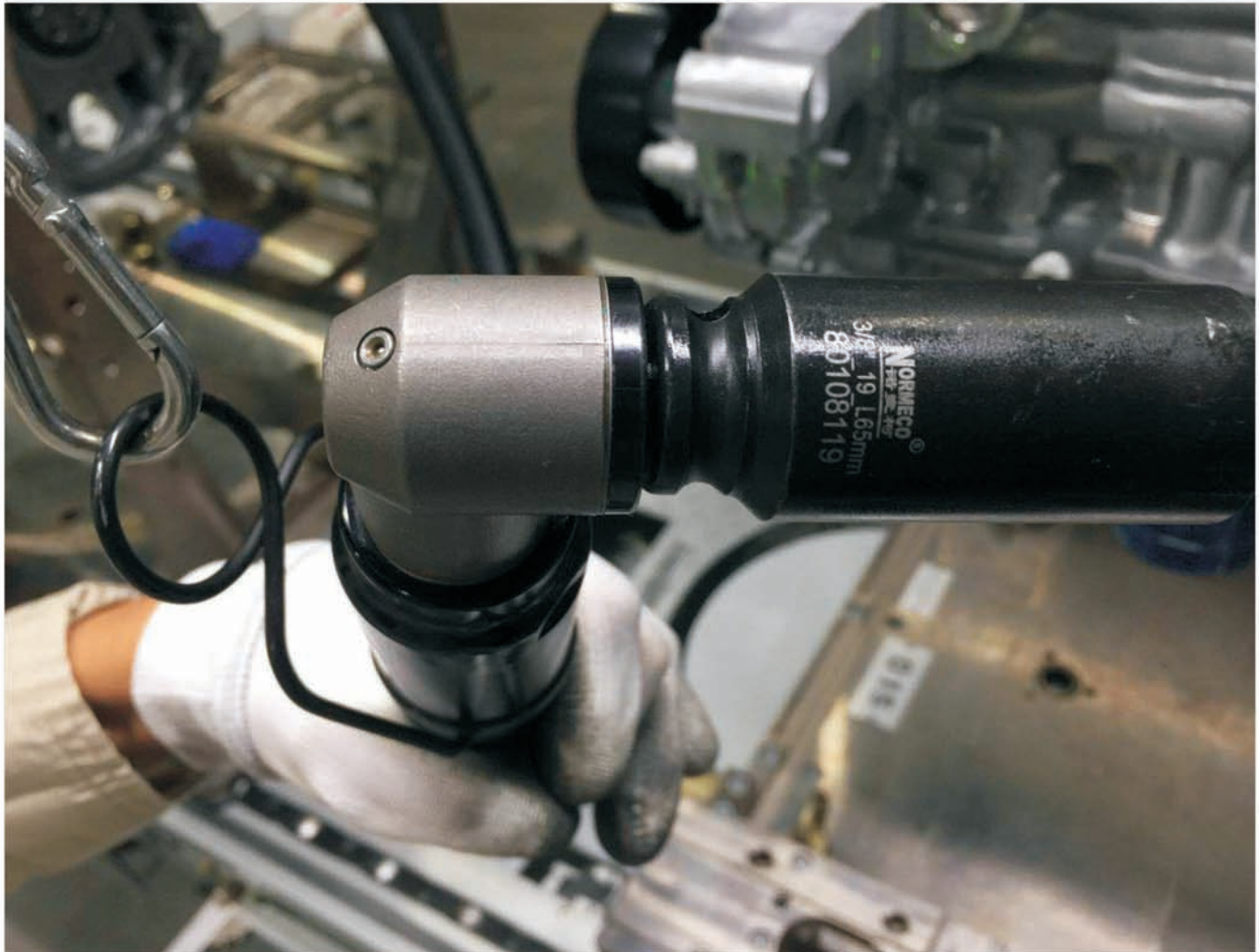

1/4"

P1-10

3/8"

P11-44

1/2"

P45-92

5/8"

P93-94

3/4"

P95-112

1"

P113-128

1-1/2"

P129-132

2-1/2"

P133-136

起子套筒

P137-145

起子头

P146-164



# NORMECO INDUSTRIAL SOCKETS

- 1/4"
- P1-10
- 3/8"
- P11-44
- 1/2"
- P45-92
- 5/8"
- P93-94
- 3/4"
- P95-112
- 1"
- P113-128
- 1-1/2"
- P129-132
- 2-1/2"
- P133-136
- 起子套筒
- P137-145
- 起子头
- P146-164

## 六角标准套筒 6-Point Sockets

3/8" Square Drive 6-Point Sockets

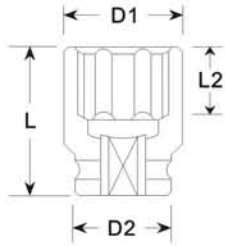

Order No.	Size inch	D2 mm	D1 mm	L2 mm	L mm
80106208	1/4 "	19	11	5	30
80106210	5/16 "	19	12.5	8	30
80106212	3/8 "	19	14.5	8	30
80106214	7/16 "	19	17	9	30
80106216	1/2 "	19	19	9	30
80106218	9/16 "	22	21	9	30
80106220	5/8 "	22	24	11	30
80106222	11/16 "	22	24	11	30
80106224	3/4 "	22	27	11	30
80106226	13/16 "	22	28	13	30
80106228	7/8 "	25	30	13	30
80106230	15/16 "	25	32	13	30
80106232	1 "	25	34	13	30

Order No.	Size mm	D2 mm	D1 mm	L2 mm	L mm
80106106	6	19	10.5	5	30
80106107	7	19	11.5	8	30
80106108	8	19	12.5	8	30
80106109	9	19	14	8	30
80106110	10	19	15	8	30
80106111	11	19	17	9	30
80106112	12	19	17.5	9	30
80106113	13	19	19	9	30
80106114	14	20	20	9	30
80106115	15	22	22	11	30
80106116	16	22	24	11	30
80106117	17	22	25	11	30
80106118	18	22	26	11	30
80106119	19	22	27	11	30
80106120	20	22	28	12	30
80106121	21	25	30	13	30
80106122	22	25	32	13	30
80106124	24	25	34	13	30



## 六角重工业型套筒 6-Point Heavy Duty Sockets

3/8" Square Drive 6-Point Sockets

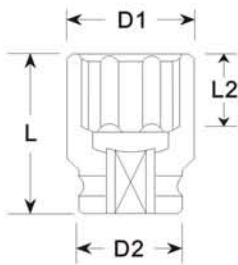

Order No.	Size mm	D2 mm	D1 mm	L2 mm	L mm
80106508	8	19	14	8	30
80106509	9	19	15	8	30
80106510	10	19	16.5	8	30
80106511	11	19	18	9	30
80106512	12	19	20	9	30
80106513	13	22	21	9	30
80106514	14	22	22	9	30
80106515	15	22	23	11	30
80106516	16	22	25	11	30
80106517	17	22	26	11	30
80106518	18	22	27	11	30



# NORMECO INDUSTRIAL SOCKETS



## 六角加长套筒 6-Point Sockets-Deep Length

 3/8" Square Drive
  6-Point Sockets

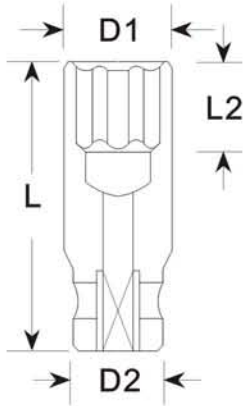

Order No.	Size inch	D2 mm	D1 mm	L2 mm	L mm
80108210	5/16 "	19	12.5	10	65
80108212	3/8 "	19	15	11	65
80108214	7/16 "	19	17	12	65
80108216	1/2 "	22	20	13	65
80108218	9/16 "	22	21	14	65
80108220	5/8 "	24	24	16	65
80108222	11/16 "	24	24	18	65
80108224	3/4 "	26	26	19	65
80108226	13/16 "	28	28	20	65
80108228	7/8 "	30	30	24	65
80108230	15/16 "	32	32	24	65
80108232	1 "	34	34	24	65

Order No.	Size mm	D2 mm	D1 mm	L2 mm	L mm
80108106	6	19	11	5	65
80108107	7	19	12.5	8	65
80108108	8	19	14	8	65
80108109	9	19	15	10	65
80108110	10	19	16	11	65
80108111	11	19	17	11	65
80108112	12	19	19	12	65
80108113	13	22	20	13	65
80108114	14	22	21	14	65
80108115	15	22	22	15	65
80108116	16	22	24	16	65
80108117	17	22	25	17	65
80108118	18	22	26	18	65
80108119	19	22	27	19	65
80108120	20	22	28	19	65
80108121	21	22	30	21	65
80108122	22	23	32	22	65
80108124	24	23	34	22	65



	1/4"
	P11-10
	3/8"
	P11-44
	1/2"
	P45-92
	5/8"
	P93-94
	3/4"
	P95-112
	1"
	P113-128
	1-1/2"
	P129-132
	2-1/2"
	P133-136
	起子套筒
	P137-145
	起子头
	P146-164



# NORMECO INDUSTRIAL SOCKETS

- 1/4"
- P1-10
- 3/8"
- P11-44
- 1/2"
- P45-92
- 5/8"
- P93-94
- 3/4"
- P95-112
- 1"
- P113-128
- 1-1/2"
- P129-132
- 2-1/2"
- P133-136
- 起子套筒
- P137-145
- 起子头
- P146-164

## 六角薄壁加长套筒 6-Point Sockets-Thin Wall Deep length

3/8" Square Drive
 6-Point Sockets

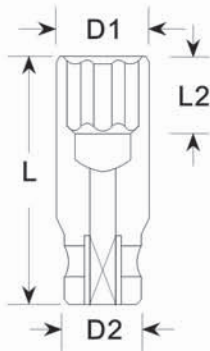

Order No.	Size inch	D2 mm	D1 mm	L2 mm	L mm
80303510	5/16 "	19	12	8	65
80303512	3/8 "	19	14	10	65
80303514	7/16 "	19	16	11	65
80303516	1/2 "	19	18	12	65
80303518	9/16 "	22	20	14	65
80303520	5/8 "	24	22.5	16	65
80303522	11/16 "	24	23.5	17	65
80303524	3/4 "	26	25	19	65
80303526	13/16 "	28	27	20	65
80303528	7/8 "	30	29	20	65
80303530	15/16 "	32	31	22	65
80303532	1 "	34	33	24	65

Order No.	Size mm	D2 mm	D1 mm	L2 mm	L mm
80303007	7	19	11.5	8	65
80303008	8	19	12.5	8	65
80303009	9	19	14	10	65
80303010	10	19	15	11	65
80303011	11	19	16	11	65
80303012	12	19	17.5	12	65
80303013	13	19	19	13	65
80303014	14	19	20	14	65
80303015	15	22	21	15	65
80303016	16	22	22.5	16	65
80303017	17	22	24	17	65
80303018	18	22	25	17	65
80303019	19	22	26	19	65
80303020	20	22	27	20	65
80303021	21	22	28	20	65
80303022	22	22	29.5	22	65
80303024	24	22	32	24	65

# NORMECO INDUSTRIAL SOCKETS



## 六角接杆套筒 6-Point Sockets-Extended length

 3/8" Square Drive
  6-Point Sockets

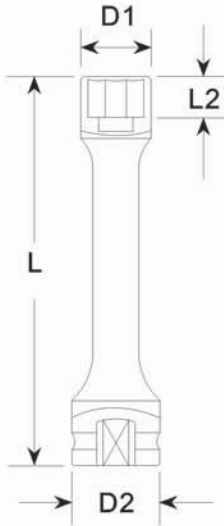

Order No.	Size mm	D2 mm	D1 mm	L2 mm	L mm
80112A08	8	19	12.5	8	125
80112A10	10	19	15.5	8	125
80112A12	12	19	18	9	125
80112A13	13	19	20	9	125
80112A14	14	19	21	9	125
80112A15	15	22	22	11	125
80112A16	16	22	24	11	125
80112A17	17	22	25	11	125

Order No.	Size mm	D2 mm	D1 mm	L2 mm	L mm
80112B08	8	19	12.5	8	150
80112B10	10	19	15.5	8	150
80112B12	12	19	18	9	150
80112B13	13	19	20	9	150
80112B14	14	19	21	9	150
80112B15	15	22	22	11	150
80112B16	16	22	24	11	150
80112B17	17	22	25	11	150
80112B19	19	22	27	12	150

Order No.	Size mm	D2 mm	D1 mm	L2 mm	L mm
80112C08	8	19	12.5	8	175
80112C10	10	19	15.5	8	175
80112C12	12	19	18	9	175
80112C13	13	19	20	9	175
80112C14	14	19	21	9	175
80112C15	15	22	22	11	175
80112C16	16	22	24	11	175
80112C17	17	22	25	11	175

Order No.	Size mm	D2 mm	D1 mm	L2 mm	L mm
80112D08	8	19	12.5	8	200
80112D10	10	19	15.5	8	200
80112D12	12	19	18	9	200
80112D13	13	19	20	9	200
80112D14	14	19	21	9	200
80112D15	15	22	22	11	200
80112D16	16	22	24	11	200
80112D17	17	22	25	11	200

Order No.	Size mm	D2 mm	D1 mm	L2 mm	L mm
80112E08	8	19	12.5	8	250
80112E10	10	19	15.5	8	250
80112E12	12	19	18	9	250
80112E13	13	19	20	9	250
80112E14	14	19	21	9	250
80112E15	15	22	22	11	250
80112E16	16	22	24	11	250
80112E17	17	22	25	11	250

	1/4"
P1-10	
	3/8"
P11-44	
	1/2"
P45-92	
	5/8"
P93-94	
	3/4"
P95-112	
	1"
P113-128	
	1-1/2"
P129-132	
	2-1/2"
P133-136	
	起子套筒
P137-145	
	起子头
P146-164	



# NORMECO INDUSTRIAL SOCKETS

- 1/4"
- P1-10
- 3/8"
- P11-44
- 1/2"
- P45-92
- 5/8"
- P93-94
- 3/4"
- P95-112
- 1"
- P113-128
- 1-1/2"
- P129-132
- 2-1/2"
- P133-136
- 起子套筒
- P137-145
- 起子头
- P146-164

## 六角固定磁标准套筒 6-Point Sockets-With Fixed Magnet

3/8" Square Drive 6-Point Sockets

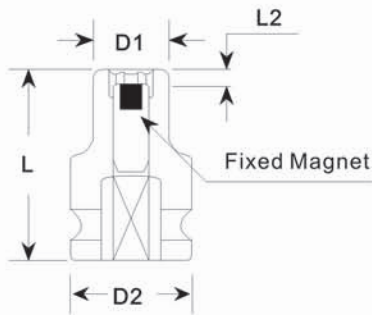

Order No.	Size inch	D2 mm	D1 mm	L2 mm	L mm
80262008	1/4"	19	11	3	30
80262010	5/16"	19	12.5	3.5	30
80262012	3/8"	19	14.5	4	30
80262014	7/16"	19	17	5	30
80262016	1/2"	19	19	5	30
80262018	9/16"	22	21	6	30
80262020	5/8"	22	24	6	30
80262022	11/16"	22	25	6	30
80262024	3/4"	22	26	7	30

Order No.	Size mm	D2 mm	D1 mm	L2 mm	L mm
80261006	6	19	10.5	3	30
80261007	7	19	11.5	3	30
80261008	8	19	12.5	3.5	30
80261009	9	19	14	4	30
80261010	10	19	15	4	30
80261011	11	19	17	5	30
80261012	12	19	17.5	5	30
80261013	13	19	19	5	30
80261014	14	20	20	6	30
80261015	15	22	22	6	30
80261016	16	22	24	6	30
80261017	17	22	25	6	30
80261018	18	22	26	7	30
80261019	19	22	27.5	7	30

## 六角伸缩磁加长套筒 6-Point Sockets-With Sliding Magnet

3/8" Square Drive 6-Point Sockets

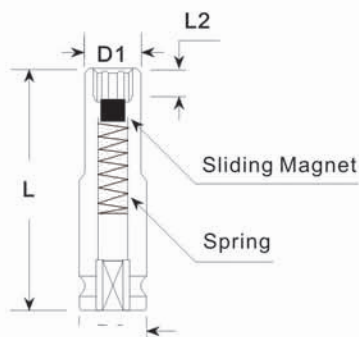

Order No.	Size inch	D2 mm	D1 mm	L2 mm	L mm
80264010	5/16"	19	14	3.5	55
80264012	3/8"	19	15.5	4	55
80264014	7/16"	19	18	5	55
80264016	1/2"	19	20	5	55
80264018	9/16"	22	21.5	6	55
80264020	5/8"	22	24	6	55
80264022	11/16"	22	25.5	6	55
80264024	3/4"	22	27.5	7	55

Order No.	Size mm	D2 mm	D1 mm	L2 mm	L mm
80263007	7	19	12.5	3	55
80263008	8	19	14	3.5	55
80263009	9	19	15	4	55
80263010	10	19	16	4	55
80263011	11	19	17.5	5	55
80263012	12	19	19	5	55
80263013	13	22	20	5	55
80263014	14	22	21	6	55
80263015	15	22	22	6	55
80263016	16	22	24	6	55
80263017	17	22	25	6	55
80263018	18	22	26	7	55
80263019	19	22	27	7	55

# NORMECO INDUSTRIAL SOCKETS



## 六角固定磁接杆套筒 6-Point Sockets-Extended length-With Fixed Magnet



3/8" Square Drive



6-Point Sockets

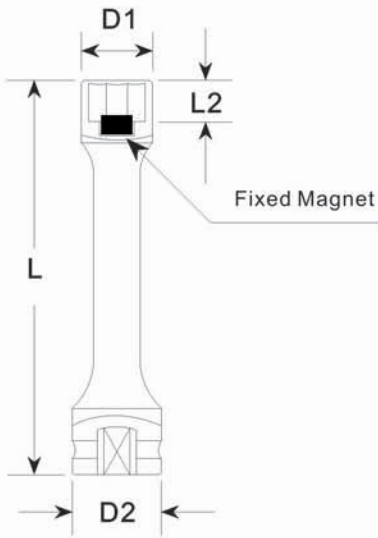

Order No.	Size mm	D2 mm	D1 mm	L2 mm	L mm
80265A08	8	19	12.5	4	125
80265A10	10	19	15.5	4	125
80265A12	12	19	18	5	125
80265A13	13	19	20	5	125
80265A14	14	19	21	6	125
80265A15	15	22	22	6	125
80265A16	16	22	24	7	125
80265A17	17	22	25	7	125

Order No.	Size mm	D2 mm	D1 mm	L2 mm	L mm
80265B08	8	19	12.5	4	150
80265B10	10	19	15.5	4	150
80265B12	12	19	18	5	150
80265B13	13	19	20	5	150
80265B14	14	19	21	6	150
80265B15	15	22	22	6	150
80265B16	16	22	24	7	150
80265B17	17	22	25	7	150
80265B19	19	22	27	7	150

Order No.	Size mm	D2 mm	D1 mm	L2 mm	L mm
80265C08	8	19	12.5	4	175
80265C10	10	19	15.5	4	175
80265C12	12	19	18	5	175
80265C13	13	19	20	6	175
80265C14	14	19	21	6	175
80265C15	15	22	22	7	175
80265C16	16	22	24	7	175
80265C17	17	22	25	7	175

Order No.	Size mm	D2 mm	D1 mm	L2 mm	L mm
80265D06	6	19	10	3	200
80265D08	8	19	12.5	4	200
80265D10	10	19	15.5	4	200
80265D12	12	19	18	5	200
80265D13	13	19	20	5	200
80265D14	14	19	21	6	200
80265D15	15	22	22	6	200
80265D16	16	22	24	7	200
80265D17	17	22	25	7	200

Order No.	Size mm	D2 mm	D1 mm	L2 mm	L mm
80265E06	6	19	10	3	250
80265E08	8	19	12.5	4	250
80265E10	10	19	15.5	4	250
80265E12	12	19	18	5	250
80265E13	13	19	20	5	250
80265E14	14	19	21	6	250
80265E15	15	22	22	6	250
80265E16	16	22	24	7	250
80265E17	17	22	25	7	250

1/4"
P1-10
3/8"
P11-44
1/2"
P45-92
5/8"
P93-94
3/4"
P95-112
1"
P113-128
1-1/2"
P129-132
2-1/2"
P133-136
起子套筒
P137-145
起子头
P146-164



# NORMECO INDUSTRIAL SOCKETS

- 1/4" P1-10
- 3/8" P11-44
- 1/2" P45-92
- 5/8" P93-94
- 3/4" P95-112
- 1" P113-128
- 1-1/2" P129-132
- 2-1/2" P133-136
- 起子套筒 P137-145
- 起子头 P146-164

## 六角伸缩磁接杆套筒 6-Point Sockets-Extended length-With Sliding Magnet

3/8" Square Drive
  6-Point Sockets

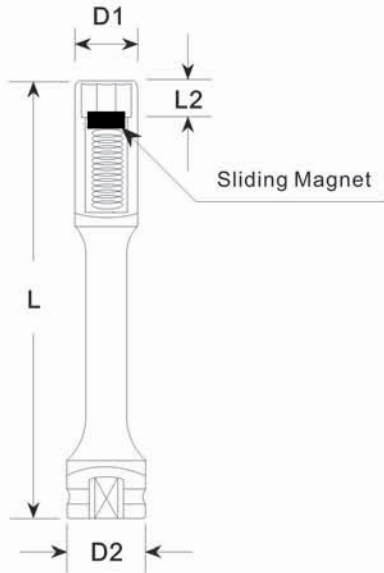

Order No.	Size mm	D2 mm	D1 mm	L2 mm	L mm
80266A08	8	20	12.5	4	100
80266A10	10	20	15.5	4	100
80266A12	12	20	18	5	100
80266A13	13	20	20	6	100
80266A14	14	20	21	6	100
80266A15	15	20	22	6	100

Order No.	Size mm	D2 mm	D1 mm	L2 mm	L mm
80266B08	8	20	12.5	4	150
80266B10	10	20	15.5	4	150
80266B12	12	20	18	5	150
80266B13	13	20	20	6	150
80266B14	14	20	21	6	150
80266B15	15	20	22	6	150

Order No.	Size mm	D2 mm	D1 mm	L2 mm	L mm
80266D08	8	20	12.5	4	200
80266D10	10	20	15.5	4	200
80266D12	12	20	18	5	200
80266D13	13	20	20	6	200
80266D14	14	20	21	6	200
80266D15	15	20	22	6	200





## 抗震动标准套筒 6-Point Anti-vibration Sockets

 3/8" Square Drive    
  6-Point Sockets  
 配合工具轴直径12mm

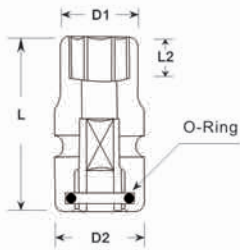

Order No.	Size mm	D2 mm	D1 mm	L2 mm	L mm
80881107	7	19	11.5	5	43
80881108	8	19	12.5	7	43
80881109	9	19	14	7	43
80881110	10	19	15	7	43
80881111	11	19	17	8	43
80881112	12	19	18	9	43
80881113	13	19	19	9	43
80881114	14	20	20	9	43
80881115	15	22	22	12	43
80881116	16	22	24	12	43
80881117	17	22	25	12	43
80881118	18	22	26	12	43
80881119	19	22	27	12	43
80881120	20	22	28	13	43
80881121	21	22	30	13	43
80881122	22	23	32	14	43



## 抗震动固定磁套筒

6-Point Anti-vibration Sockets With Fixed Magnet

 3/8" Square Drive    
  6-Point Sockets

注：1、动力工具轴直径12mm。  
2、□□套筒六角对边尺寸。

Remarks: 1. Power tools drive shaft dia 12mm.  
2. □□ hex AF size.

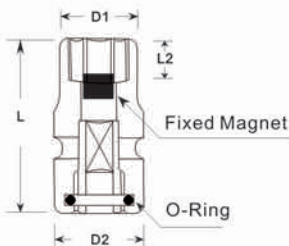

Order No.	Size mm	D2 mm	D1 mm	L2 mm	L mm
80881□□FM	□□	80881□□	80881□□	802610□□	43



-  1/4"
- P1-10
-  3/8"
- P11-44
-  1/2"
- P45-92
-  5/8"
- P93-94
-  3/4"
- P95-112
-  1"
- P113-128
-  1-1/2"
- P129-132
-  2-1/2"
- P133-136
-  起子套筒
- P137-145
- 起子头
- P146-164



# NORMECO INDUSTRIAL SOCKETS

1/4"
P1-10
3/8"
P11-44
1/2"
P45-92
5/8"
P93-94
3/4"
P95-112
1"
P113-128
1-1/2"
P129-132
2-1/2"
P133-136
起子套筒
P137-145
起子头
P146-164

## 抗震动加长套筒

6-Point Anti-vibration Sockets With Deep Length

3/8" Square Drive 6-Point Sockets  
配合工具轴直径12mm

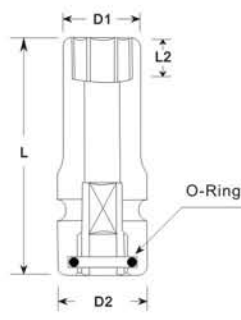

Order No.	Size mm	D2 mm	D1 mm	L2 mm	L mm
80881508	8	19	12	7	80
80881509	9	19	15	7	80
80881510	10	19	15	7	80
80881511	11	19	17	8	80
80881512	12	19	18	9	80
80881513	13	19	19	9	80
80881514	14	20	20	9	80
80881515	15	22	22	12	80
80881516	16	22	24	12	80
80881517	17	22	25	12	80
80881518	18	22	26	12	80
80881519	19	22	27	12	80
80881520	20	22	28	13	80
80881521	21	22	30	13	80
80881522	22	23	32	14	80

## 抗震动伸缩磁套筒

6-Point Anti-vibration Sockets With Sliding Magnet

3/8" Square Drive 6-Point Sockets

注：1、动力工具轴直径12mm。  
2、□□套筒六角对边尺寸。

Remarks: 1. Power tools drive shaft dia 12mm.  
2. □□ hex AF size.

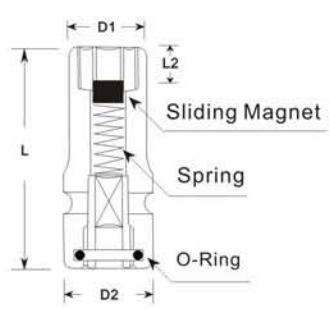

Order No.	Size mm	D2 mm	D1 mm	L2 mm	L mm
808815□□ SM	□□	808815□□	808815□□	802630□□	80



## ▶ 抗震动接杆套筒

6-Point Anti-vibration Sockets -Extended length

 3/8" Square Drive  
 配合工具轴直径12mm

 6-Point Sockets

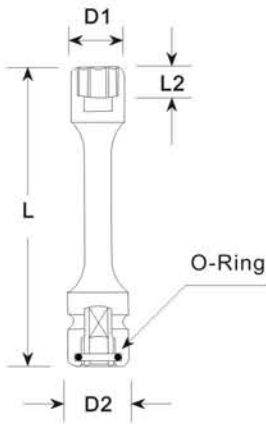

Order No.	Size mm	D2 mm	D1 mm	L2 mm	L mm
80882A08	8	19	12.5	8	100
80882A10	10	19	15.5	8	100
80882A12	12	19	18	9	100
80882A13	13	19	20	9	100
80882A14	14	19	21	9	100
80882A15	15	22	22	11	100
80882A16	16	22	24	11	100
80882A17	17	22	25	11	100

Order No.	Size mm	D2 mm	D1 mm	L2 mm	L mm
80882B08	8	19	12.5	8	150
80882B10	10	19	15.5	8	150
80882B12	12	19	18	9	150
80882B13	13	19	20	9	150
80882B14	14	19	21	9	150
80882B15	15	22	22	11	150
80882B16	16	22	24	11	150
80882B17	17	22	25	11	150

Order No.	Size mm	D2 mm	D1 mm	L2 mm	L mm
80882D08	8	19	12.5	8	200
80882D10	10	19	15.5	8	200
80882D12	12	19	18	9	200
80882D13	13	19	20	9	200
80882D14	14	19	21	9	200
80882D15	15	22	22	11	200
80882D16	16	22	24	11	200
80882D17	17	22	25	11	200

Order No.	Size mm	D2 mm	D1 mm	L2 mm	L mm
80882E08	8	19	12.5	8	250
80882E10	10	19	15.5	8	250
80882E12	12	19	18	9	250
80882E13	13	19	20	9	250
80882E14	14	19	21	9	250
80882E15	15	22	22	11	250
80882E16	16	22	24	11	250
80882E17	17	22	25	11	250

## ▶ 抗震动固定磁接杆套筒

6-Point Anti-vibration Sockets With Fixed Magnet

 3/8" Square Drive

 6-Point Sockets

注：1、动力工具轴直径12mm。

2、□□套筒六角对边尺寸。

Remarks:1.Power tools drive shaft dia 12mm.

2.□□ hex AF size.

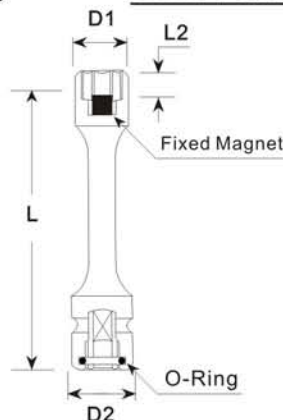

Order No.	Size mm	D2 mm	D1 mm	L2 mm	L mm
80882A□□ FM	□□	80882A□□	80882A□□	802610□□	100
80882B□□ FM	□□	80882B□□	80882B□□	802610□□	150
80882D□□ FM	□□	80882D□□	80882D□□	802610□□	200

1/4"

P1-10

3/8"

P11-44

1/2"

P45-92

5/8"

P93-94

3/4"

P95-112

1"

P113-128

1-1/2"

P129-132

2-1/2"

P133-136

起子套筒

P137-145

起子头

P146-164



# NORMECO INDUSTRIAL SOCKETS

- 1/4"
- P1-10
- 3/8"
- P11-44
- 1/2"
- P45-92
- 5/8"
- P93-94
- 3/4"
- P95-112
- 1"
- P113-128
- 1-1/2"
- P129-132
- 2-1/2"
- P133-136
- 起子套筒
- P137-145
- 起子头
- P146-164

## 六角万向标准套筒 6-Point Universal Sockets

3/8" Square Drive 6-Point Sockets

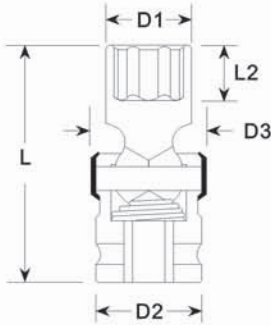

Order No.	Size inch	D3 mm	D2 mm	D1 mm	L2 mm	L mm
80353010	5/16"	27	22	14	9	53
80353012	3/8"	27	22	15	9	53
80353014	7/16"	27	22	17	9	53
80353016	1/2"	27	22	18	12	53
80353018	9/16"	27	22	21	13	53
80353020	5/8"	27	22	23	13	53
80353022	11/16"	27	22	25	13	53
80353024	3/4"	27	22	27	13	53
80353026	13/16"	27	22	30	13	53
80353028	7/8"	27	22	32	13	53

Order No.	Size mm	D3 mm	D2 mm	D1 mm	L2 mm	L mm
80352009	9	27	22	15	8	53
80352010	10	27	22	15	8	53
80352011	11	27	22	17	9	53
80352012	12	27	22	19	10	53
80352013	13	27	22	19	11	53
80352014	14	27	22	21	12	53
80352015	15	27	22	22	12	53
80352016	16	27	22	23	13	53
80352017	17	27	22	25	13	53
80352018	18	27	22	25	13	53
80352019	19	27	22	27	13	53
80352020	20	27	22	30	13	53
80352021	21	27	22	30	13	53
80352022	22	27	22	32	13	53

## 六角万向加长套筒 6-Point Universal-Deep length

3/8" Square Drive 6-Point Sockets

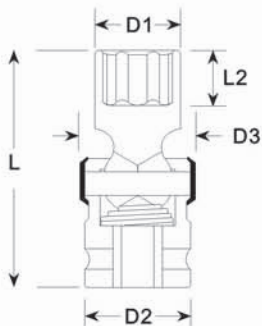

Order No.	Size inch	D3 mm	D2 mm	D1 mm	L2 mm	L mm
80355510	5/16"	27	22	14	8	74
80355512	3/8"	27	22	15	10	78
80355514	7/16"	27	22	17	10	80
80355516	1/2"	27	22	18	12	80
80355518	9/16"	27	22	19	13	80
80355520	5/8"	27	22	23	14	80
80355522	11/16"	27	22	25	14	80
80355524	3/4"	27	22	27	14	80
80355526	13/16"	27	22	30	14	80
80355528	7/8"	27	22	32	14	80

Order No.	Size mm	D3 mm	D2 mm	D1 mm	L2 mm	L mm
80355009	9	27	22	15	8	78
80355010	10	27	22	15	10	78
80355011	11	27	22	17	10	80
80355012	12	27	22	19	12	80
80355013	13	27	22	19	13	80
80355014	14	27	22	21	13	80
80355015	15	27	22	22	13	80
80355016	16	27	22	23	14	80
80355017	17	27	22	25	14	80
80355018	18	27	22	25	14	80
80355019	19	27	22	27	14	80
80355020	20	27	22	30	14	80
80355021	21	27	22	30	14	80
80355022	22	27	22	32	14	80

# NORMECO INDUSTRIAL SOCKETS



## 六角万向接杆套筒 6-Point Universal Extension

3/8" Square Drive 6-Point Sockets



Order No.	Size mm	D3 mm	D2 mm	D1 mm	L2 mm	L mm
80356A08	8	19	19	12.5	9	100
80356A10	10	19	19	16	9	100
80356A12	12	20	20	17.5	9	100
80356A13	13	21	20	19	11	100
80356A14	14	22	20	20	11	100
80356A15	15	24	20	22	11	100
80356B08	8	19	19	12.5	9	150
80356B10	10	19	19	16	9	150
80356B12	12	20	20	17.5	9	150
80356B13	13	21	20	19	11	150
80356B14	14	22	20	20	11	150
80356B15	15	24	20	22	11	150
80356D08	8	19	19	12.5	9	200
80356D10	10	19	19	16	9	200
80356D12	12	20	20	17.5	9	200
80356D13	13	21	20	19	11	200
80356D14	14	22	20	20	11	200
80356D15	15	24	20	22	11	200

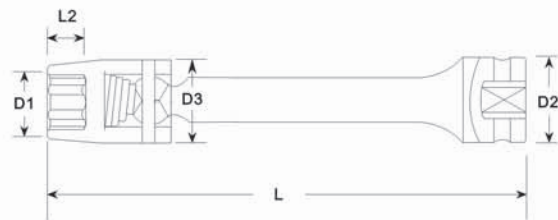

## 六角万向接杆套筒 6-Point Universal Extension

3/8" Square Drive 6-Point Sockets



Order No.	Size mm	D3 mm	D2 mm	D1 mm	L2 mm	L mm
80357B08	8	27	19	12.5	9	150
80357B10	10	27	19	15	9	150
80357B12	12	27	19	17.5	9	150
80357B13	13	27	19	19	11	150
80357B14	14	27	19	20	11	150
80357B15	15	27	19	22	11	150
80357D08	8	27	19	12.5	9	200
80357D10	10	27	19	15	9	200
80357D12	12	27	19	17.5	9	200
80357D13	13	27	19	19	11	200
80357D14	14	27	19	20	11	200
80357D15	15	27	19	22	11	200
80357E08	8	27	19	12.5	9	250
80357E10	10	27	19	15	9	250
80357E12	12	27	19	17.5	9	250
80357E13	13	27	19	19	11	250
80357E14	14	27	19	20	11	250
80357E15	15	27	19	22	11	250

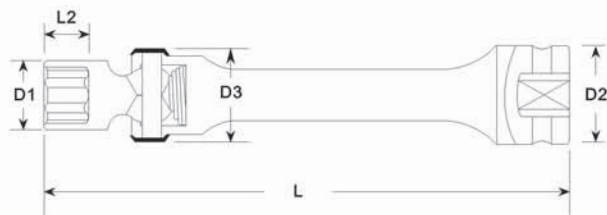

1/4"
P1-10
3/8"
P11-44
1/2"
P45-92
5/8"
P93-94
3/4"
P95-112
1"
P113-128
1-1/2"
P129-132
2-1/2"
P133-136
起子套筒
P137-145
起子头
P146-164



# NORMECO INDUSTRIAL SOCKETS

1/4"	P1-10
3/8"	P11-44
1/2"	P45-92
5/8"	P93-94
3/4"	P95-112
1"	P113-128
1-1/2"	P129-132
2-1/2"	P133-136
起子套筒	P137-145
起子头	P146-164

## 十二角标准套筒 12-Point Sockets

 3/8" Square Drive
  12-Point Sockets

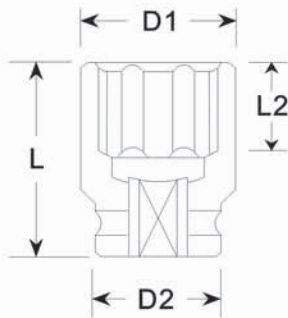

Order No.	Size inch	D2 mm	D1 mm	L2 mm	L mm
80207008	1/4"	19	11	5	30
80207010	5/16"	19	13	6	30
80207012	3/8"	19	15	6	30
80207014	7/16"	19	17.5	8	30
80207016	1/2"	19	20	9	30
80207018	9/16"	22	21.5	11	32
80207020	5/8"	22	24	11	32
80207022	11/16"	22	25.5	11	32
80207024	3/4"	22	27.5	13	34
80207026	13/16"	22	30	15	34
80207028	7/8"	25	32	15	34
80207030	15/16"	25	34	16	34
80207100	1"	25	35.5	16	36
80207102	1-1/16"	25	38	16	36

Order No.	Size mm	D2 mm	D1 mm	L2 mm	L mm
80206006	6	19	11	5	30
80206007	7	19	12	5	30
80206008	8	19	13	6	30
80206009	9	19	15	6	30
80206010	10	19	16.5	7	30
80206011	11	19	17.5	8	30
80206012	12	19	19	9	30
80206013	13	22	20	9	30
80206014	14	22	21.5	11	32
80206015	15	22	22	11	32
80206016	16	22	24	11	32
80206017	17	22	25	11	32
80206018	18	22	26	13	34
80206019	19	22	27.5	13	34
80206020	20	22	28	13	34
80206021	21	25	30	15	34
80206022	22	25	32	15	34
80206023	23	25	33	15	34
80206024	24	25	34	16	34
80206025	25	25	35	16	36
80206026	26	25	36	16	36
80206027	27	25	38	16	36

# NORMECO INDUSTRIAL SOCKETS



## 十二角加长套筒 12-Point Sockets-Deep length

 3/8" Square Drive
  12-Point Sockets

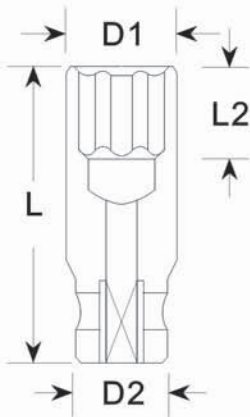

Order No.	Size inch	D2 mm	D1 mm	L2 mm	L mm
80209008	1/4"	19	11	5	63
80209010	5/16"	19	13	6	63
80209012	3/8"	19	15	6	65
80209014	7/16"	19	17.5	8	65
80209016	1/2"	19	20	9	65
80209018	9/16"	22	21.5	11	65
80209020	5/8"	22	24	11	65
80209022	11/16"	22	25.5	11	65
80209024	3/4"	22	27.5	13	65
80209026	13/16"	22	30	15	65
80209028	7/8"	23	32	15	65
80209030	15/16"	23	34	16	65
80209100	1"	23	35.5	16	65
80209102	1-1/16"	23	38	16	65

Order No.	Size mm	D2 mm	D1 mm	L2 mm	L mm
80208006	6	19	11	5	63
80208007	7	19	12	5	63
80208008	8	19	13	6	63
80208009	9	19	15	6	65
80208010	10	19	16.5	7	65
80208011	11	19	17.5	8	65
80208012	12	19	19	9	65
80208013	13	22	20	9	65
80208014	14	22	21.5	11	65
80208015	15	22	22	11	65
80208016	16	22	24	11	65
80208017	17	22	25	11	65
80208018	18	22	26	13	65
80208019	19	22	27.5	13	65
80208020	20	22	28	13	65
80208021	21	22	30	15	65
80208022	22	22	32	15	65
80208023	23	22	33	15	65
80208024	24	22	34	16	65
80208025	25	22	35	16	65
80208026	26	22	36	16	65
80208027	27	22	38	16	65



	1/4"
	P1-10
	3/8"
	P11-44
	1/2"
	P45-92
	5/8"
	P93-94
	3/4"
	P95-112
	1"
	P113-128
	1-1/2"
	P129-132
	2-1/2"
	P133-136
	起子套筒
	P137-145
	起子头
	P146-164



# NORMECO INDUSTRIAL SOCKETS

- 1/4"
- P1-10
- 3/8"
- P11-44
- 1/2"
- P45-92
- 5/8"
- P93-94
- 3/4"
- P95-112
- 1"
- P113-128
- 1-1/2"
- P129-132
- 2-1/2"
- P133-136
- 起子套筒
- P137-145
- 起子头
- P146-164

## 十二角接杆套筒 12-Point Sockets-Extended length

3/8" Square Drive
 12-Point Sockets

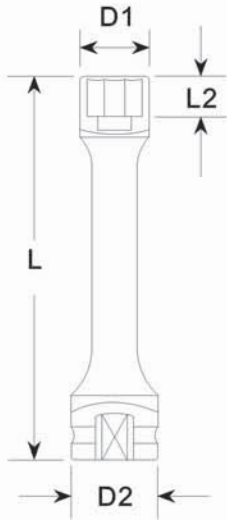

Order No.	Size mm	D2 mm	D1 mm	L2 mm	L mm
80212A08	8	19	12.5	8	125
80212A10	10	19	15.5	8	125
80212A12	12	19	18	9	125
80212A13	13	19	20	9	125
80212A14	14	19	21	9	125
80212A15	15	22	22	11	125
80212A16	16	22	24	11	125
80212A17	17	22	25	11	125

Order No.	Size mm	D2 mm	D1 mm	L2 mm	L mm
80212B08	8	19	12.5	8	150
80212B10	10	19	15.5	8	150
80212B12	12	19	18	9	150
80212B13	13	19	20	9	150
80212B14	14	19	21	9	150
80212B15	15	22	22	11	150
80212B16	16	22	24	11	150
80212B17	17	22	25	11	150

Order No.	Size mm	D2 mm	D1 mm	L2 mm	L mm
80212C08	8	19	12.5	8	175
80212C10	10	19	15.5	8	175
80212C12	12	19	18	9	175
80212C13	13	19	20	9	175
80212C14	14	19	21	9	175
80212C15	15	22	22	11	175
80212C16	16	22	24	11	175
80212C17	17	22	25	11	175

Order No.	Size mm	D2 mm	D1 mm	L2 mm	L mm
80212D08	8	19	12.5	8	200
80212D10	10	19	15.5	8	200
80212D12	12	19	18	9	200
80212D13	13	19	20	9	200
80212D14	14	19	21	9	200
80212D15	15	22	22	11	200
80212D16	16	22	24	11	200
80212D17	17	22	25	11	200

Order No.	Size mm	D2 mm	D1 mm	L2 mm	L mm
80212E08	8	19	12.5	8	250
80212E10	10	19	15.5	8	250
80212E12	12	19	18	9	250
80212E13	13	19	20	9	250
80212E14	14	19	21	9	250
80212E15	15	22	22	11	250
80212E16	16	22	24	11	250
80212E17	17	22	25	11	250



## 十二角固定磁标准套筒 12-Point Sockets-With Fixed Magnet

3/8" Square Drive 12-Point Sockets

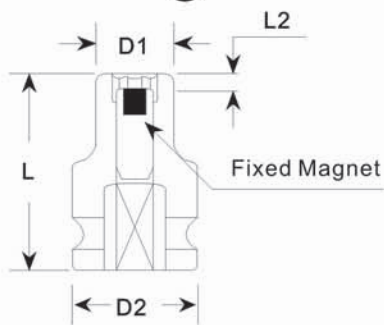

Order No.	Size Inch	D2 mm	D1 mm	L2 mm	L mm
80286008	1/4"	19	12	3	30
80286010	5/16"	19	14	3.5	30
80286012	3/8"	19	15.5	4	30
80286014	7/16"	19	18	5	30
80286016	1/2"	19	20	5	30
80286018	9/16"	20	21.5	6	32
80286020	5/8"	22	24	6	32
80286022	11/16"	22	25.5	6	32
80286024	3/4"	22	27.5	7	34

Order No.	Size mm	D2 mm	D1 mm	L2 mm	L mm
80285006	6	19	11	3	30
80285007	7	19	12	3	30
80285008	8	19	13	3.5	30
80285009	9	19	15	4	30
80285010	10	19	16.5	4	30
80285011	11	19	17.5	5	30
80285012	12	19	19	5	30
80285013	13	22	20	5	30
80285014	14	22	21.5	6	32
80285015	15	22	22	6	32
80285016	16	22	24	6	32
80285017	17	22	25	6	32
80285018	18	22	26	7	34
80285019	19	22	27.5	7	34

## 十二角伸缩磁加长套筒 12-Point Sockets-With Sliding Magnet

3/8" Square Drive 12-Point Sockets

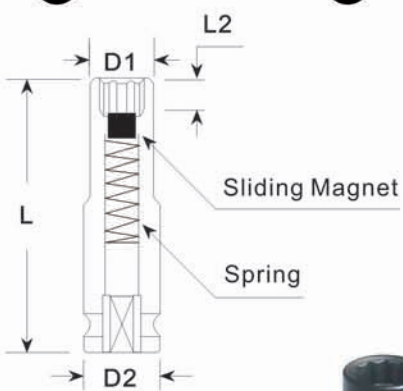

Order No.	Size inch	D2 mm	D1 mm	L2 mm	L mm
80288010	5/16"	19	14	3.5	55
80288012	3/8"	19	15.5	4	55
80288014	7/16"	19	18	5	55
80288016	1/2"	20	20	5	55
80288018	9/16"	22	21.5	6	55
80288020	5/8"	22	24	6	55
80288022	11/16"	22	25.5	6	55
80288024	3/4"	22	27.5	7	55

Order No.	Size mm	D2 mm	D1 mm	L2 mm	L mm
80287007	7	19	12	3	55
80287008	8	19	13	3.5	55
80287009	9	19	15	4	55
80287010	10	19	16.5	4	55
80287011	11	19	17.5	5	55
80287012	12	19	19	5	55
80287013	13	22	20	5	55
80287014	14	22	21.5	6	55
80287015	15	22	22	6	55
80287016	16	22	24	6	55
80287017	17	22	25	6	55
80287018	18	22	26	7	55
80287019	19	22	27.5	7	55



# NORMECO INDUSTRIAL SOCKETS

- 1/4"
- P1-10
- 3/8"
- P11-44
- 1/2"
- P45-92
- 5/8"
- P93-94
- 3/4"
- P95-112
- 1"
- P113-128
- 1-1/2"
- P129-132
- 2-1/2"
- P133-136
- 起子套筒
- P137-145
- 起子头
- P146-164

## 十二角固定磁接杆套筒 12-Point Sockets-Extented length-With Fixed Magnet

3/8" Square Drive      12-Point Sockets

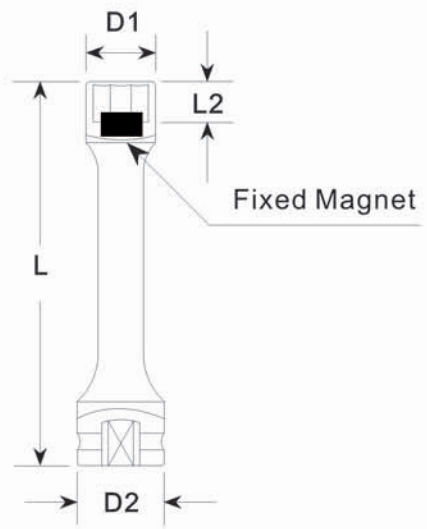

Order No.	Size mm	D2 mm	D1 mm	L2 mm	L mm
80291A08	8	19	12.5	4	125
80291A10	10	19	15.5	4	125
80291A12	12	19	18	5	125
80291A13	13	19	20	6	125
80291A14	14	22	21	6	125
80291A15	15	22	22	7	125
80291A16	16	22	24	7	125
80291A17	17	22	25	8	125

Order No.	Size mm	D2 mm	D1 mm	L2 mm	L mm
80291B08	8	19	12.5	4	150
80291B10	10	19	15.5	4	150
80291B12	12	19	18	5	150
80291B13	13	19	20	6	150
80291B14	14	22	21	6	150
80291B15	15	22	22	7	150
80291B16	16	22	24	7	150
80291B17	17	22	25	8	150

Order No.	Size mm	D2 mm	D1 mm	L2 mm	L mm
80291C08	8	19	12.5	4	175
80291C10	10	19	15.5	4	175
80291C12	12	19	18	5	175
80291C13	13	19	20	6	175
80291C14	14	22	21	6	175
80291C15	15	22	22	7	175
80291C16	16	22	24	7	175
80291C17	17	22	25	8	175

Order No.	Size mm	D2 mm	D1 mm	L2 mm	L mm
80291D08	8	19	12.5	4	200
80291D10	10	19	15.5	4	200
80291D12	12	19	18	5	200
80291D13	13	19	20	6	200
80291D14	14	22	21	6	200
80291D15	15	22	22	7	200
80291D16	16	22	24	7	200
80291D17	17	22	25	8	200

Order No.	Size mm	D2 mm	D1 mm	L2 mm	L mm
80291E08	8	19	12.5	4	250
80291E10	10	19	15.5	4	250
80291E12	12	19	18	5	250
80291E13	13	19	20	6	250
80291E14	14	22	21	6	250
80291E15	15	22	22	7	250
80291E16	16	22	24	7	250
80291E17	17	22	25	8	250



## 六角大圆弧标准套筒 6-Point Surface Drive Sockets

 3/8" Square Drive
  Surface Drive Sockets

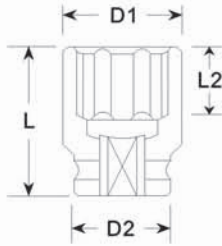

Order No.	Size mm	D2 mm	D1 mm	L2 mm	L mm
80465208	8	19	13.8	8	32
80465209	9	19	15	8	32
80465210	10	19	16	8	32
80465211	11	19	17.5	9	32
80465212	12	19	19	9	32
80465213	13	19	20	9	32
80465214	14	22	22	9	32
80465215	15	22	23	11	32
80465216	16	22	24	11	32
80465217	17	22	25	11	32
80465218	18	22	26	11	32
80465219	19	22	28	11	32

Order No.	Size inch	D2 mm	D1 mm	L2 mm	L mm
80465258	1/4"	19	11.5	4	32
80465260	5/16"	19	13.8	8	32
80465262	3/8"	19	15.5	8	32
80465264	7/16"	19	17.5	9	32
80465266	1/2"	22	20	9	32
80465268	9/16"	22	22	11	32
80465270	5/8"	22	24	11	32
80465272	11/16"	22	26	11	32
80465274	3/4"	22	28	11	32





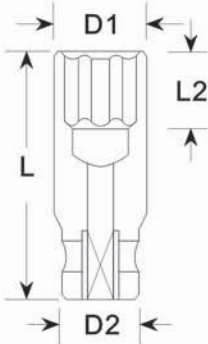















## 六角大圆弧加长套筒 6-Point Surface Drive Sockets-Deep

 3/8" Square Drive
  Surface Drive Sockets-Deep



Order No.	Size mm	D2 mm	D1 mm	L2 mm	L mm
80465308	8	19	13.8	10	80
80465309	9	19	15	10	80
80465310	10	19	16	10	80
80465311	11	19	17.5	12	80
80465312	12	19	19	12	80
80465313	13	22	20	12	80
80465314	14	22	22	14	80
80465315	15	22	23	14	80
80465316	16	22	24	14	80
80465317	17	22	25	17	80
80465318	18	22	26	17	80
80465319	19	22	28	19	80

Order No.	Size inch	D2 mm	D1 mm	L2 mm	L mm
80465358	1/4"	19	11.5	4	80
80465360	5/16"	19	13.8	8	80
80465362	3/8"	19	15.5	8	80
80465364	7/16"	19	17.5	9	80
80465366	1/2"	22	20	9	80
80465368	9/16"	22	22	11	80
80465370	5/8"	22	24	11	80
80465372	11/16"	22	26	11	80
80465374	3/4"	22	28	11	80

	1/4"
	P1-10
	3/8"
	P11-44
	1/2"
	P45-92
	5/8"
	P93-94
	3/4"
	P95-112
	1"
	P113-128
	1-1/2"
	P129-132
	2-1/2"
	P133-136
	起子套筒
	P137-145
	起子头
	P146-164



# NORMECO INDUSTRIAL SOCKETS

1/4"
P1-10
3/8"
P11-44
1/2"
P45-92
5/8"
P93-94
3/4"
P95-112
1"
P113-128
1-1/2"
P129-132
2-1/2"
P133-136
起子套筒
P137-145
起子头
P146-164

## 四方标准套筒 4-Point Female Sockets

3/8" Square Drive 4-Point Female Sockets

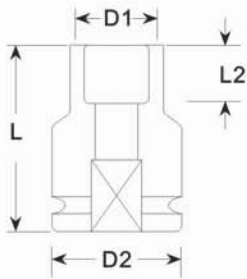

Order No.	□ Square	□ Size mm	D2 mm	D1 mm	L2 mm	L mm
80178108	3/8"	8	19	16	7	32
80178109	3/8"	9	19	17.5	7	32
80178110	3/8"	10	19	19	8	32
80178112	3/8"	12	19	24	10	35
80178114	3/8"	14	19	27.5	12	35



## 外星型标准套筒 External Torx

3/8" Square Drive External Torx

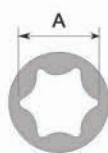
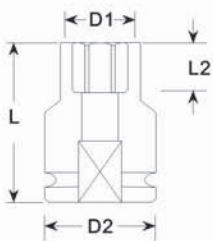

Order No.	☆	A mm	D2 mm	D1 mm	L2 mm	L mm
80175005	E5	4.72	19	8.5	4.5	32
80175006	E6	5.69	19	9.5	5	32
80175007	E7	6.17	19	10	6	32
80175008	E8	7.47	19	11.5	6	32
80175010	E10	9.37	19	13.5	7.5	32
80175011	E11	10	19	14	8	32
80175012	E12	11.1	19	15.5	8.5	32
80175014	E14	12.85	19	17.5	10	32
80175016	E16	14.7	19	19	11	32
80175018	E18	16.6	22	21	12.5	34
80175020	E20	18.4	22	24	14	34
80175022	E22	20.3	22	26	15	36
80175024	E24	22.2	22	28	16.5	36





## ▶ 外星型薄壁标准套筒 External Torx-Thin Wall

3/8" Square Drive

External Torx-Thin Wall

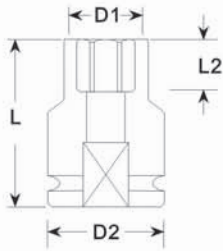

Order No.		A mm	D2 mm	D1 mm	L2 mm	L mm
80175205	E5	4.72	19	8	4.5	32
80175206	E6	5.69	19	8.5	5	32
80175207	E7	6.17	19	9.3	6	32
80175208	E8	7.47	19	10	6	32
80175210	E10	9.37	19	12.3	7.5	32
80175211	E11	10	19	13	8	32
80175212	E12	11.1	19	14	8.5	32
80175214	E14	12.85	19	16.5	10	32
80175216	E16	14.7	19	18.4	11	32
80175218	E18	16.6	22	20	12.5	34
80175220	E20	18.4	22	23	14	34
80175222	E22	20.3	22	25	15	36
80175224	E24	22.2	22	27	16.5	36



## ▶ 外星型固定磁标准套筒 External Torx Sockets-With Fixed Magnet

3/8" Square Drive

External Torx

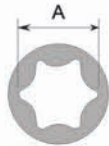
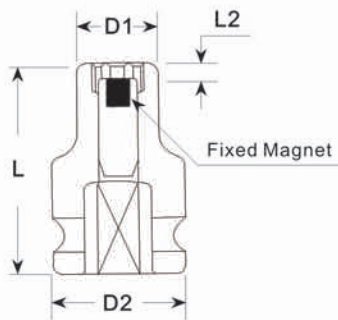

Order No.		A mm	D2 mm	D1 mm	L2 mm	L mm
80177108	E8	7.47	19	11.5	5	32
80177110	E10	9.37	19	13.5	5.5	32
80177111	E11	10	19	14	5.5	32
80177112	E12	11.1	19	15.5	6	32
80177114	E14	12.85	19	17.5	8	32
80177116	E16	14.7	19	19	9	32
80177118	E18	16.6	21	21	9	32



1/4"

P1-10

3/8"

P11-44

1/2"

P45-92

5/8"

P93-94

3/4"

P95-112

1"

P113-128

1-1/2"

P129-132

2-1/2"

P133-136

起子套筒

P137-145

起子头

P146-164



# NORMECO INDUSTRIAL SOCKETS

- 1/4" P11-10
- 3/8" P11-44
- 1/2" P45-92
- 5/8" P93-94
- 3/4" P95-112
- 1" P113-128
- 1-1/2" P129-132
- 2-1/2" P133-136
- 起子套筒 P137-145
- 起子头 P146-164

## 外星型加长套筒 External Torx-Deep Length

3/8" Square Drive External Torx-Deep Length

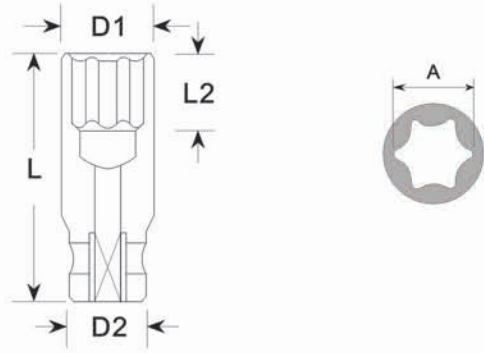

Order No.	Drive	A mm	D2 mm	D1 mm	L2 mm	L mm
80175305	E5	4.72	19	8.5	4.5	63
80175306	E6	5.69	19	9.5	5	63
80175307	E7	6.17	19	10	6	63
80175308	E8	7.47	19	11.5	6.5	63
80175310	E10	9.37	19	13.5	7.5	63
80175311	E11	10	19	14	8	63
80175312	E12	11.1	19	15.5	8.5	63
80175314	E14	12.85	19	17.5	10	65
80175316	E16	14.7	19	19	11	65
80175318	E18	16.6	22	21	12.5	65
80175320	E20	18.4	22	24	14	65
80175322	E22	20.3	22	26	15	65
80175324	E24	22.2	22	28	16.5	65



## 双头螺栓套筒 Stud Bolt Impact Sockets

3/8" Square Drive Stud Bolt

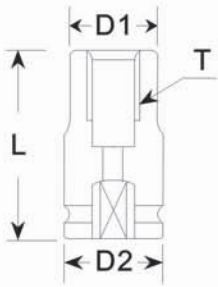

Order No.	Drive	Stud Bolt	D2 mm	D1 mm	L mm
80182112	3/8"	M5×P0.8	19	12	40
80182115	3/8"	M6×P1.0	19	12.5	50
80182117	3/8"	M7×P1.0	19	13	50
80182120	3/8"	M8×P1.0	19	15	50
80182121	3/8"	M8×P1.25	19	15	50
80182125	3/8"	M10×P1.25	19	17	50
80182126	3/8"	M10×P1.5	19	17	50
80182132	3/8"	M12×P1.25	22	20	55
80182138	3/8"	M14×P1.5	22	22	65
80182152	3/8"	1/4"-20UNC	19	12.5	50
80182156	3/8"	5/16"-18UNC	19	15	50
80182158	3/8"	3/8"-16UNC	19	15	50
80182160	3/8"	7/16"-14UNC	19	17	50





## 丝攻套筒 Tap Holding Sockets

3/8" Square Drive Tap

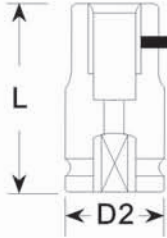

Order No.	3/8" Square	Sq mm	T Size	D2 mm	L mm
80180140	3/8"	4	M4 M4.5	19	42
80180145	3/8"	4.5	M5 M6	19	42
80180150	3/8"	5	M7 M8	19	42
80180155	3/8"	5.5	M10	19	42
80180165	3/8"	6.5	M12	19	42



## 旋护套筒 Standard Sockets With Rotating Cover

3/8" Square Drive

Rotating Cover  
Flat Rotating Cover

Order No.	Size mm	D2 mm	D1 mm	L2 mm	L mm
No. + RC	-	-	-	-	-
No. + FRC	-	-	-	-	-

6-Point Sockets  
六角套筒

12-Point Sockets  
十二角套筒

6-Point Surface Drive Sockets  
大圆弧套筒

External Torx Sockets  
外星型套筒

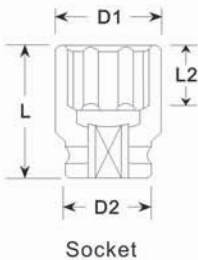

Rotating Cover  
端面防护型

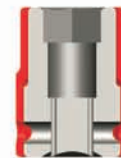

Flat Rotating Cover  
端面齐平型

诺麦柯旋护套筒实现套筒在护套内的自由旋转，从而减少或消除紧固作业中人与旋转部件的接触，除了提高操作人员安全性，同时也有助于最大限度地减少系统损坏和紧固过程中造成的碰撞。

Normeco rotating cover is designed to enable the impact socket spinning freely inside the cover, Which significantly reducing or even eliminating the access between operators and rotating parts during tightening. It improves safety, and helps to minimize the risk of system damage and marring work pieces during fastening operation.



1/4"

P11-10

3/8"

P11-44

1/2"

P45-92

5/8"

P93-94

3/4"

P95-112

1"

P113-128

1-1/2"

P129-132

2-1/2"

P133-136

起子套筒

P137-145

起子头

P146-164



# NORMECO INDUSTRIAL SOCKETS

- 1/4"
- P1-10
- 3/8"
- P11-44
- 1/2"
- P45-92
- 5/8"
- P93-94
- 3/4"
- P95-112
- 1"
- P113-128
- 1-1/2"
- P129-132
- 2-1/2"
- P133-136
- 起子套筒
- P137-145
- 起子头
- P146-164

## 内六角套筒 Male Hex Drive Sockets

3/8" Square Drive    Hex Drive

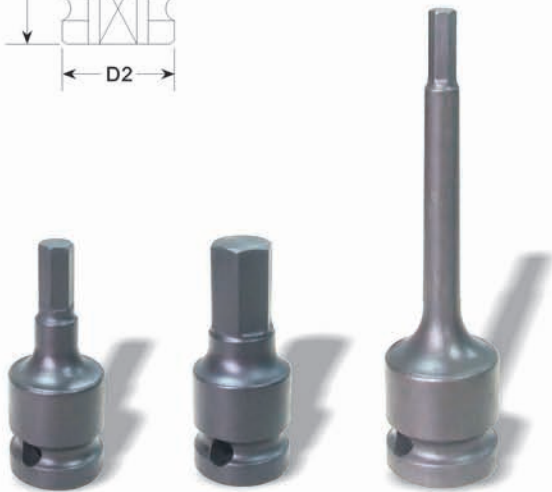
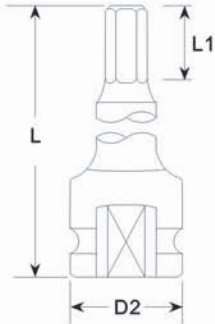

Order No.	Size inch	D2 mm	L1 mm	L mm
80512005	5/32"	19	9	50
80512006	3/16"	19	11	50
80512007	7/32"	19	11	50
80512008	1/4"	19	11	50
80512009	9/32"	19	16	50
80512010	5/16"	19	16	50
80512012	3/8"	19	16	50
80512014	7/16"	19	16	50
80512016	1/2"	22	16	50
80512018	9/16"	22	16	50
80512020	5/8"	22	16	50

Order No.	Size inch	D2 mm	L1 mm	L mm
80516006	3/16"	19	11	100
80516007	7/32"	19	11	100
80516008	1/4"	19	11	100
80516009	9/32"	19	16	100
80516010	5/16"	19	16	100
80516012	3/8"	19	16	100
80516014	7/16"	19	16	100
80516016	1/2"	22	16	100
80516018	9/16"	22	16	100
80516020	5/8"	22	16	100

Order No.	Size inch	D2 mm	L1 mm	L mm
80520006	3/16"	19	11	150
80520007	7/32"	19	11	150
80520008	1/4"	19	11	150
80520009	9/32"	19	16	150
80520010	5/16"	19	16	150
80520012	3/8"	19	16	150
80520014	7/16"	19	16	150
80520016	1/2"	22	16	150
80520018	9/16"	22	16	150
80520020	5/8"	22	16	150

Order No.	Size mm	D2 mm	L1 mm	L mm
80510003	3	19	11	50
80510004	4	19	11	50
80510005	5	19	11	50
80510006	6	19	11	50
80510007	7	19	16	50
80510008	8	19	16	50
80510009	9	19	16	50
80510010	10	19	16	50
80510011	11	19	16	50
80510012	12	19	16	50
80510013	13	22	16	50
80510014	14	22	16	50
80510015	15	22	16	50
80510016	16	22	16	50

Order No.	Size mm	D2 mm	L1 mm	L mm
80514004	4	19	11	100
80514005	5	19	11	100
80514006	6	19	11	100
80514007	7	19	16	100
80514008	8	19	16	100
80514009	9	19	16	100
80514010	10	19	16	100
80514011	11	19	16	100
80514012	12	19	16	100
80514013	13	22	16	100
80514014	14	22	16	100
80514015	15	22	16	100
80514016	16	22	16	100

Order No.	Size mm	D2 mm	L1 mm	L mm
80518004	4	19	11	150
80518005	5	19	11	150
80518006	6	19	11	150
80518007	7	19	16	150
80518008	8	19	16	150
80518009	9	19	16	150
80518010	10	19	16	150
80518011	11	19	16	150
80518012	12	19	16	150
80518013	13	22	16	150
80518014	14	22	16	150
80518015	15	22	16	150
80518016	16	22	16	150



▶ 内十二角套筒 Triple square Sockets

 3/8" Square Drive
  Triple square Sockets

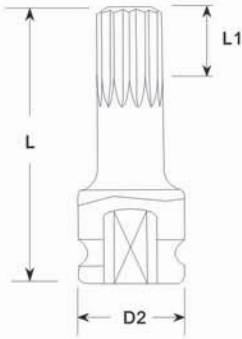

Order No.	Size	D2 mm	L1 mm	L mm
80582605	M5	19	7	50
80582606	M6	19	7	50
80582608	M8	19	8	50
80582610	M10	19	8	50
80582612	M12	22	10	50
80582614	M14	22	11	50
80582616	M16	22	13	50

Order No.	Size	D2 mm	L1 mm	L mm
80582635	M5	19	7	100
80582636	M6	19	7	100
80582638	M8	19	8	100
80582640	M10	19	8	100
80582642	M12	22	10	100
80582644	M14	22	11	100
80582646	M16	22	13	100

Order No.	Size	D2 mm	L1 mm	L mm
80582675	M5	19	7	150
80582676	M6	19	7	150
80582678	M8	19	8	150
80582680	M10	19	8	150
80582682	M12	22	10	150
80582684	M14	22	11	150
80582686	M16	22	13	150



 1/4"

P1-10

 3/8"

P11-44

 1/2"

P45-92

 5/8"

P93-94

 3/4"

P95-112

 1"

P113-128

 1-1/2"

P129-132

 2-1/2"

P133-136

 起子套筒

P137-145

 起子头

P146-164



# NORMECO INDUSTRIAL SOCKETS

- 1/4"
- P1-10
- 3/8"
- P11-44
- 1/2"
- P45-92
- 5/8"
- P93-94
- 3/4"
- P95-112
- 1"
- P113-128
- 1-1/2"
- P129-132
- 2-1/2"
- P133-136
- 起子套筒
- P137-145
- 起子头
- P146-164

## 内星型套筒 Internal Torx Sockets

3/8" Square Drive Internal Torx Sockets

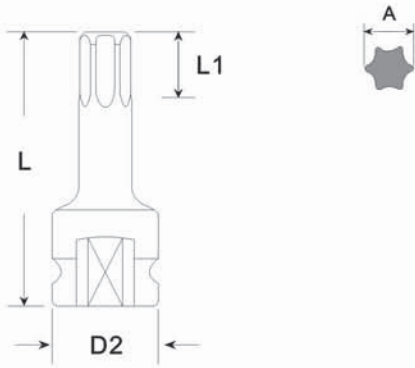

Order No.	★	A mm	D2 mm	L1 mm	L mm
80172020	T20	3.84	19	2.8	50
80172025	T25	4.4	19	3	50
80172027	T27	4.96	19	3	50
80172030	T30	5.5	19	3.5	50
80172040	T40	6.6	19	4	50
80172045	T45	7.77	19	4.5	50
80172047	T47	7.96	19	4.5	50
80172050	T50	8.8	19	5	50
80172055	T55	11.2	19	5.5	50

Order No.	★	A mm	D2 mm	L1 mm	L mm
80172220	T20	3.84	19	2.8	100
80172225	T25	4.4	19	3	100
80172227	T27	4.96	19	3	100
80172230	T30	5.5	19	3.5	100
80172240	T40	6.6	19	4	100
80172245	T45	7.77	19	4.5	100
80172247	T47	7.96	19	4.5	100
80172250	T50	8.8	19	5	100
80172255	T55	11.2	19	5.5	100

Order No.	★	A mm	D2 mm	L1 mm	L mm
80172320	T20	3.84	19	2.8	150
80172325	T25	4.4	19	3	150
80172327	T27	4.96	19	3	150
80172330	T30	5.5	19	3.5	150
80172340	T40	6.6	19	4	150
80172345	T45	7.77	19	4.5	150
80172347	T47	7.96	19	4.5	150
80172350	T50	8.8	19	5	150
80172355	T55	11.2	19	5.5	150

## 旋护内方套筒 Rotating Cover Sockets

3/8" Square Drive

Hex Sockets 内六角套筒 Internal Torx Sockets 内星型套筒

Triple square Sockets 内十二角套筒

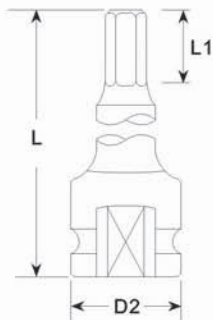

诺麦柯旋护套筒实现套筒在护套内的自由旋转，从而减少或消除紧固作业中人与旋转部件的接触，除了提高操作人员安全性，同时也有助于最大限度地减少系统损坏和紧固过程中造成的碰撞。

Normeco rotating cover is designed to enable the impact socket spinning freely inside the cover, which significantly reducing or even eliminating the access between operators and rotating parts during tightening. It improves safety, and help to minimize the risk of system damage and marring work pieces during fastening operation.

Order No.	D2 mm	L mm
No. +RC	-	-



## ▶ 延长杆 Extension Bars

3/8" Square Drive   
  Square

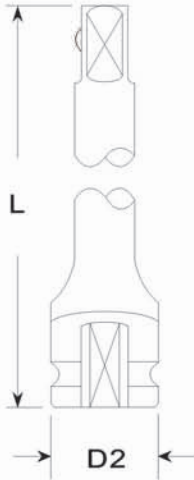

Order No.	<span style="display: inline-block; width: 10px; height: 10px; border: 1px solid black;"></span> Inch	<span style="display: inline-block; width: 10px; height: 10px; background-color: black;"></span> Inch	D2 mm	L mm	Male End Type
80617050	3/8"	3/8"	19	50	Steel Ball
80617075	3/8"	3/8"	19	75	Steel Ball
80617100	3/8"	3/8"	19	100	Steel Ball
80617125	3/8"	3/8"	19	125	Steel Ball
80617150	3/8"	3/8"	19	150	Steel Ball
80617175	3/8"	3/8"	19	175	Steel Ball
80617200	3/8"	3/8"	19	200	Steel Ball
80617250	3/8"	3/8"	19	250	Steel Ball
80617300	3/8"	3/8"	19	300	Steel Ball

Order No.	<span style="display: inline-block; width: 10px; height: 10px; border: 1px solid black;"></span> Inch	<span style="display: inline-block; width: 10px; height: 10px; background-color: black;"></span> Inch	D2 mm	L mm	Male End Type
80619050	3/8"	3/8"	19	50	Lock Pin
80619075	3/8"	3/8"	19	75	Lock Pin
80619100	3/8"	3/8"	19	100	Lock Pin
80619125	3/8"	3/8"	19	125	Lock Pin
80619150	3/8"	3/8"	19	150	Lock Pin
80619175	3/8"	3/8"	19	175	Lock Pin
80619200	3/8"	3/8"	19	200	Lock Pin
80619250	3/8"	3/8"	19	250	Lock Pin
80619300	3/8"	3/8"	19	300	Lock Pin

Order No.	<span style="display: inline-block; width: 10px; height: 10px; border: 1px solid black;"></span> Inch	<span style="display: inline-block; width: 10px; height: 10px; background-color: black;"></span> Inch	D2 mm	L mm	Male End Type
80622050	3/8"	3/8"	19	50	Pin Hole
80622075	3/8"	3/8"	19	75	Pin Hole
80622100	3/8"	3/8"	19	100	Pin Hole
80622125	3/8"	3/8"	19	125	Pin Hole
80622150	3/8"	3/8"	19	150	Pin Hole
80622175	3/8"	3/8"	19	175	Pin Hole
80622200	3/8"	3/8"	19	200	Pin Hole
80622250	3/8"	3/8"	19	250	Pin Hole
80622300	3/8"	3/8"	19	300	Pin Hole

<span style="display: inline-block; width: 10px; height: 10px; border: 1px solid black;"></span>	1/4"
P1-10	<span style="display: inline-block; width: 10px; height: 10px; border: 1px solid black;"></span>
<span style="display: inline-block; width: 10px; height: 10px; background-color: black;"></span>	3/8"
P11-44	<span style="display: inline-block; width: 10px; height: 10px; border: 1px solid black;"></span>
<span style="display: inline-block; width: 10px; height: 10px; border: 1px solid black;"></span>	1/2"
P45-92	<span style="display: inline-block; width: 10px; height: 10px; border: 1px solid black;"></span>
<span style="display: inline-block; width: 10px; height: 10px; border: 1px solid black;"></span>	5/8"
P93-94	<span style="display: inline-block; width: 10px; height: 10px; border: 1px solid black;"></span>
<span style="display: inline-block; width: 10px; height: 10px; border: 1px solid black;"></span>	3/4"
P95-112	<span style="display: inline-block; width: 10px; height: 10px; border: 1px solid black;"></span>
<span style="display: inline-block; width: 10px; height: 10px; border: 1px solid black;"></span>	1"
P113-128	<span style="display: inline-block; width: 10px; height: 10px; border: 1px solid black;"></span>
<span style="display: inline-block; width: 10px; height: 10px; border: 1px solid black;"></span>	1-1/2"
P129-132	<span style="display: inline-block; width: 10px; height: 10px; border: 1px solid black;"></span>
<span style="display: inline-block; width: 10px; height: 10px; border: 1px solid black;"></span>	2-1/2"
P133-136	<span style="display: inline-block; width: 10px; height: 10px; border: 1px solid black;"></span>
<span style="display: inline-block; width: 10px; height: 10px; background-color: black;"></span>	起子套筒
P137-145	<span style="display: inline-block; width: 10px; height: 10px; border: 1px solid black;"></span>
<span style="display: inline-block; width: 10px; height: 10px; border: 1px solid black;"></span>	起子头
P146-164	<span style="display: inline-block; width: 10px; height: 10px; border: 1px solid black;"></span>



# NORMECO INDUSTRIAL SOCKETS

1/4"
P1-10
3/8"
P11-44
1/2"
P45-92
5/8"
P93-94
3/4"
P95-112
1"
P113-128
1-1/2"
P129-132
2-1/2"
P133-136
起子套筒
P137-145
起子头
P146-164

## ▶ 抗震型延长杆 Anti Vibration Extension Bar

3/8" Square Drive    Square

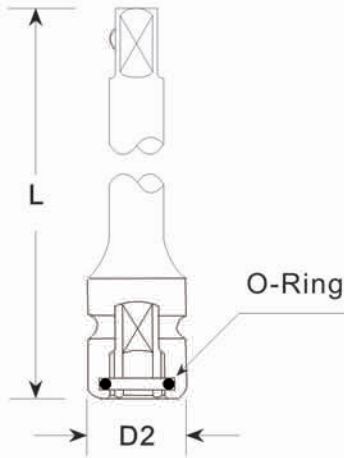

Order No.	□ Inch	■ Inch	D2 mm	L mm	Male End Type
80641050	3/8"	3/8"	19	50	Steel Ball
80641075	3/8"	3/8"	19	75	Steel Ball
80641100	3/8"	3/8"	19	100	Steel Ball
80641125	3/8"	3/8"	19	125	Steel Ball
80641150	3/8"	3/8"	19	150	Steel Ball
80641175	3/8"	3/8"	19	175	Steel Ball
80641200	3/8"	3/8"	19	200	Steel Ball
80641250	3/8"	3/8"	19	250	Steel Ball
80641300	3/8"	3/8"	19	300	Steel Ball

Order No.	□ Inch	■ Inch	D2 mm	L mm	Male End Type
80642050	3/8"	3/8"	19	50	Lock Pin
80642075	3/8"	3/8"	19	75	Lock Pin
80642100	3/8"	3/8"	19	100	Lock Pin
80642125	3/8"	3/8"	19	125	Lock Pin
80642150	3/8"	3/8"	19	150	Lock Pin
80642175	3/8"	3/8"	19	175	Lock Pin
80642200	3/8"	3/8"	19	200	Lock Pin
80642250	3/8"	3/8"	19	250	Lock Pin
80642300	3/8"	3/8"	19	300	Lock Pin

Order No.	□ Inch	■ Inch	D2 mm	L mm	Male End Type
80643050	3/8"	3/8"	19	50	Pin Hole
80643075	3/8"	3/8"	19	75	Pin Hole
80643100	3/8"	3/8"	19	100	Pin Hole
80643125	3/8"	3/8"	19	125	Pin Hole
80643150	3/8"	3/8"	19	150	Pin Hole
80643175	3/8"	3/8"	19	175	Pin Hole
80643200	3/8"	3/8"	19	200	Pin Hole
80643250	3/8"	3/8"	19	250	Pin Hole
80643300	3/8"	3/8"	19	300	Pin Hole



## ▶ 万向接头 Universal Joints

3/8" Square Drive    3/8" Square

Order No.	D2 mm	L mm	Male End Type
80668510	24	50	Steel Ball
80668512	24	50	Pin Hole
80668514	24	50	Lock Pin

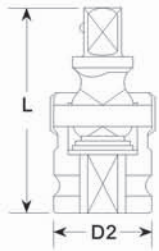

Steel Ball  
钢珠头

Lock Pin  
插销头

Pin Hole  
插销孔



## ▶ 颤动万向头 Wobble Adapter

3/8" Square Drive    3/8" Square

Order No.	D2 mm	L mm	Male End Type
80668580	19	38	Pin Hole

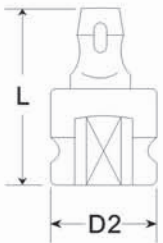

## ▶ 旋护延长杆 Extension Bars With Rotating Cover

3/8" Square Drive    Extension Bars

Order No.	D2 mm	L mm	Male End Type
No. +RC	-	-	Steel Ball
No. +RC	-	-	Lock Pin

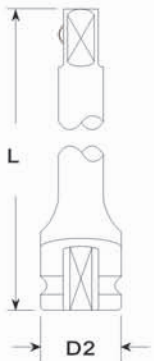

Steel Ball  
钢珠式



Lock Pin  
锁销式



1/4"
P1-10
3/8"
P11-44
1/2"
P45-92
5/8"
P93-94
3/4"
P95-112
1"
P113-128
1-1/2"
P129-132
2-1/2"
P133-136
起子套筒
P137-145
起子头
P146-164



# NORMECO INDUSTRIAL SOCKETS

- 1/4"
- P1-10
- 3/8"
- P11-44
- 1/2"
- P45-92
- 5/8"
- P93-94
- 3/4"
- P95-112
- 1"
- P113-128
- 1-1/2"
- P129-132
- 2-1/2"
- P133-136
- 起子套筒
- P137-145
- 起子头
- P146-164

## 转换头 Adapter From Hex. To Male Square

Hex 3/8" Square

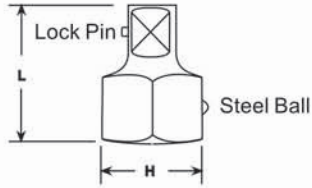

Order No.	Inch	H mm	L mm
80663210	3/8"	10	24
80663211	3/8"	11	24
80663212	3/8"	12	24
80663213	3/8"	13	24
80663214	3/8"	14	24
80663215	3/8"	15	24
80663216	3/8"	16	24
80663217	3/8"	17	24
80663218	3/8"	18	26
80663219	3/8"	19	26

## 转换头 Adapter

3/8" Square Drive Square

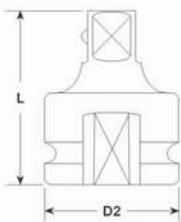

Order No.	Inch	Inch	D2 mm	L mm	Male End Type
80665040	3/8"	1/4"	19	32	Lock Pin
80665045	3/8"	1/4"	19	50	Lock Pin
80665050	3/8"	1/4"	19	75	Lock Pin
80665055	3/8"	1/4"	19	100	Lock Pin
80665060	3/8"	1/4"	19	125	Lock Pin
80665065	3/8"	1/4"	19	150	Lock Pin

Order No.	Inch	Inch	D2 mm	L mm	Male End Type
80665070	3/8"	1/4"	19	32	Pin Hole
80665075	3/8"	1/4"	19	50	Pin Hole
80665080	3/8"	1/4"	19	75	Pin Hole
80665085	3/8"	1/4"	19	100	Pin Hole
80665090	3/8"	1/4"	19	125	Pin Hole
80665095	3/8"	1/4"	19	150	Pin Hole

Order No.	Inch	Inch	D2 mm	L mm	Male End Type
80665100	3/8"	1/2"	22	36	Steel Ball
80665105	3/8"	1/2"	22	36	Lock Pin
80665110	3/8"	1/2"	22	36	Pin Hole
80665150	3/8"	1/2"	22	150	Pin Hole

Order No.	Inch	Inch	D2 mm	L mm	Male End Type
80665010	3/8"	1/4"	19	32	Steel Ball
80665015	3/8"	1/4"	19	50	Steel Ball
80665020	3/8"	1/4"	19	75	Steel Ball
80665025	3/8"	1/4"	19	100	Steel Ball
80665030	3/8"	1/4"	19	125	Steel Ball
80665035	3/8"	1/4"	19	150	Steel Ball



Steel Ball 钢珠式



Lock Pin 锁销式



Pin Hole 销孔式



▶ 转换头 Adapter

 3/8" Square Drive
  6-Point

Order No.	 Inch	 Inch	D2 mm	D1 mm	L2 mm	L mm
80668015	3/8"	1/4"	19	19	24.5	45

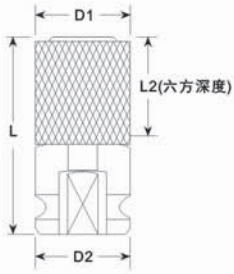

 1/4"

P11-10

 3/8"

P11-44

 1/2"

P45-92

 5/8"

P93-94

 3/4"

P95-112

 1"

P113-128

 1-1/2"

P129-132

 2-1/2"

P133-136

 起子套筒

P137-145

起子头

P146-164

▶ 转换头 Adapter

 3/8" Square Drive
  6-Point

Order No.	 Inch	 Inch	D2 mm	D1 mm	L2 mm	L mm
80668010	3/8"	1/4"	19	12	23	40

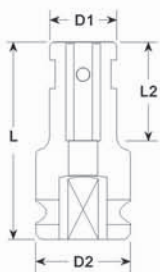



# NORMECO INDUSTRIAL SOCKETS

1/4"
P1-10
3/8"
P11-44
1/2"
P45-92
5/8"
P93-94
3/4"
P95-112
1"
P113-128
1-1/2"
P129-132
2-1/2"
P133-136
起子套筒
P137-145
起子头
P146-164

## 快换式转换杆 Quick-Change Adapter

  3/8" Square Drive   
  Square

Order No.	<span style="border: 1px solid black; border-radius: 50%; padding: 2px;"> </span> Inch	<span style="display: inline-block; width: 10px; height: 10px; background-color: black; margin-right: 5px;"></span> Inch	D2 mm	L mm	Male End Type
80666304	3/8"	1/4"	19	38	Steel Ball
80666307	3/8"	1/4"	19	75	Steel Ball
80666310	3/8"	1/4"	19	100	Steel Ball
80666312	3/8"	1/4"	19	125	Steel Ball
80666315	3/8"	1/4"	19	150	Steel Ball
80666325	3/8"	1/4"	19	250	Steel Ball
80666330	3/8"	1/4"	19	300	Steel Ball

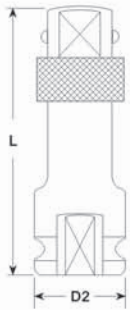

## 快换式延长杆 Quick-Change Extens Bars

  3/8" Square Drive   
  Square

Order No.	<span style="border: 1px solid black; border-radius: 50%; padding: 2px;"> </span> Inch	<span style="display: inline-block; width: 10px; height: 10px; background-color: black; margin-right: 5px;"></span> Inch	D2 mm	L mm	Male End Type
80622510	3/8"	3/8"	19	46	Steel Ball
80622515	3/8"	3/8"	19	75	Steel Ball
80622520	3/8"	3/8"	19	100	Steel Ball
80622525	3/8"	3/8"	19	125	Steel Ball
80622530	3/8"	3/8"	19	150	Steel Ball
80622535	3/8"	3/8"	19	250	Steel Ball
80622540	3/8"	3/8"	19	300	Steel Ball

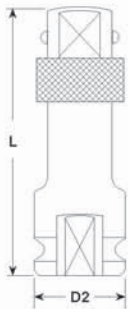



## 绝缘转换头、套筒 Isolated Adapter & Sockets

3/8" Square Drive
  6-Point Sockets

### 绝缘转换头 Isolated Adapter

Order No.	<span style="display: inline-block; width: 10px; height: 10px; border: 1px solid black; margin-right: 2px;"></span> Inch	<span style="display: inline-block; width: 10px; height: 10px; background-color: black; margin-right: 2px;"></span> Inch	D2 mm	L mm	Male End Type
IS383850A	3/8"	3/8"	25	50.2	Steel Ball
IS383850B	3/8"	3/8"	25	50.2	Steel Ball & Sheath Thread

### 绝缘套筒 Isolated Socket

Order No.	<span style="display: inline-block; width: 10px; height: 10px; border: 1px solid black; margin-right: 2px;"></span> Square	<span style="display: inline-block; width: 10px; height: 10px; border: 1px solid black; border-radius: 50%; margin-right: 2px;"></span> Size mm	D2 mm	D1 mm	L2 mm	L mm
IS380850A	3/8"	8	25	16	7	50
IS381050A	3/8"	10	25	18.8	8	50
IS381250A	3/8"	12	25	21	8.5	50
IS381350A	3/8"	13	25	21.5	9	50
IS381450A	3/8"	14	25	23	10	50
IS381650A	3/8"	16	25	25	12	50

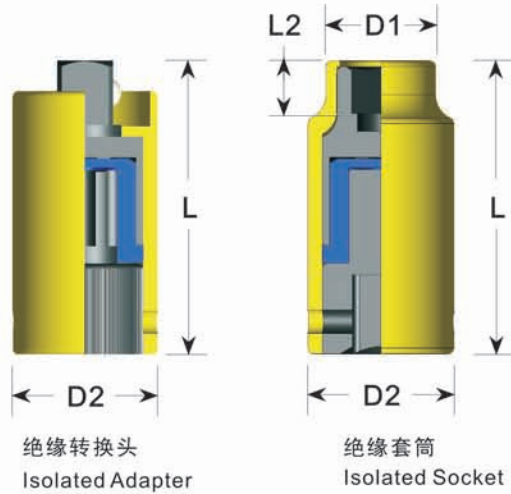

**IEC60900** CQAMQI Test Report ( IEC60060.1 )  
 live working-hand tools for use up to 1000 V AC and 1500 V DC

Non-conductivity — Radial isolation 径向绝缘  
 Axial isolation 轴向绝缘

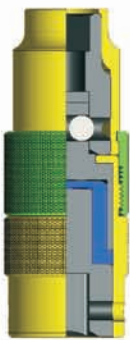

护套螺纹 Sheath Thread



最大使用扭力30nm。  
 Maximum torque used: 30nm

### Applications



警告 WARNING

Always wear safety goggles when using impact tools. Do not hold socket while in use.  
 使用时请穿戴好保护身体各部位的相应防护用品，严禁在没有任何保护的情况下使用。

Product improvement is continuing. Designs and specifications are changing without prior notice. The company reserves the right to modify the catalogue.

本目录中的所有参数如有变动，恕不另行通知，本公司保留对样本进行修改的权利。

1/4"

P1-10

3/8"

P11-44

1/2"

P45-92

5/8"

P93-94

3/4"

P95-112

1"

P113-128

1-1/2"

P129-132

2-1/2"

P133-136

起子套筒

P137-145

起子头

P146-164



# NORMECO INDUSTRIAL SOCKETS

1/4"	P1-10	3/8"	P11-44	1/2"	P45-92	5/8"	P93-94	3/4"	P95-112	1"	P113-128	1-1/2"	P129-132	2-1/2"	P133-136	起子套筒	P137-145	起子头	P146-164
------	-------	------	--------	------	--------	------	--------	------	---------	----	----------	--------	----------	--------	----------	------	----------	-----	----------

▶ 非标准套筒 Custom-Made Sockets					Special Parts Applications				
起子套筒式双头螺栓套筒 Stud Bolt Bit Socket	单向棘轮抗震延长杆组件 Anti-vibration Extension With Ratchet Head	快速切换式穿心套筒 Quick-change Bit Through Socket	专用工具套筒 Custom-made Socket	拧紧机专用套筒 Multiple Nut-runner Socket	氧传感器套筒 Oxygen Sensor Socket	三斜齿型快速导入套筒 Triple Slopes Fast Lead Socket	防轮毂划伤护套套筒 Wheel Assembly Socket With Protective Sleeve	六角型四方套筒 Male Hex To Square Head Socket	大倒角型快速导入套筒 Fast Lead Socket
异形套筒 Special Socket	拧紧机套筒连接头 Multiple Nut-runner Adapter	专用工具套筒组件 Special Tool Socket	专用工具套筒组件 Special Tool Socket	氧传感器套筒 Oxygen Sensor Socket	万向深内孔接杆套筒 Deep-length Of Universal Extension	五方手动扳杆 Penta Socket Wrench	多点磁抗震性套筒 Anti-vibration Socket With Side Magnets	异形套筒 Special Socket	防轮毂划伤护套套筒 Wheel Assembly Socket With Protective Sleeve
凸键槽套筒 Axial Nut Socket	凹键槽套筒 Axial Nut Socket	异形双磁铁套筒 Special Socket With Double Magnets	内外六角套筒 Male & Female Hex Socket	气动油压扳手治具 Oil-pulse Tool Fixture					

# NORMECO INDUSTRIAL SOCKETS



## NORMECO套筒应用

## Special Parts Applications

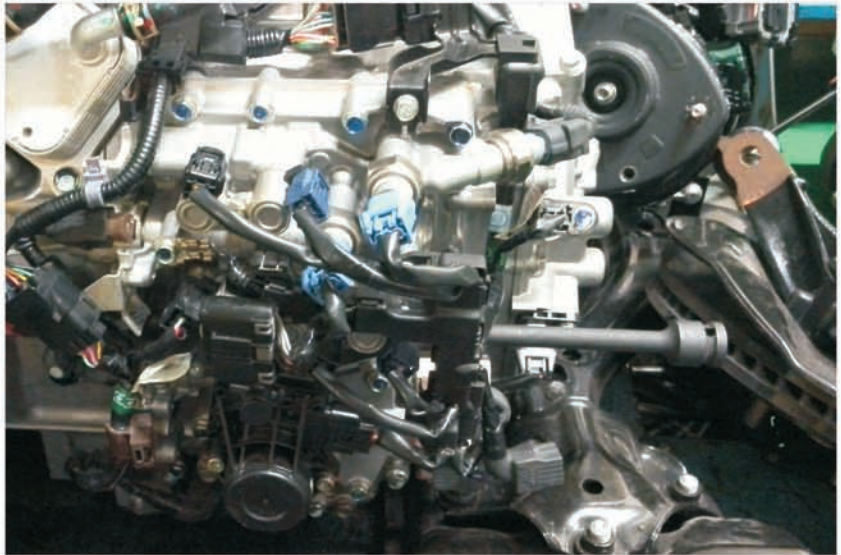

1/4"

P11-10



3/8"

P11-44



1/2"

P45-92



5/8"

P93-94



3/4"

P95-112



1"

P113-128



1-1/2"

P129-132



2-1/2"

P133-136



起子套筒

P137-145

起子头

P146-164



# NORMECO INDUSTRIAL SOCKETS

1/4"	P1-10
3/8"	P11-44
1/2"	P45-92
5/8"	P93-94
3/4"	P95-112
1"	P113-128
1-1/2"	P129-132
2-1/2"	P133-136
起子套筒	P137-145
起子头	P146-164

## 六角标准套筒 6-Point Sockets

1/2" Square Drive 6-Point Sockets

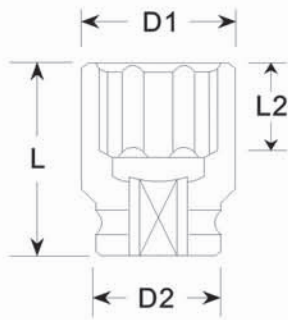

Order No.	Size inch	D2 mm	D1 mm	L2 mm	L mm
80116210	5/16 "	25	14	8	38
80116212	3/8 "	25	16	8	38
80116214	7/16 "	25	18	12	38
80116216	1/2 "	25	20	12	38
80116218	9/16 "	25	22	12	38
80116220	5/8 "	25	25	12	38
80116222	11/16 "	26	26	13	38
80116224	3/4 "	28	28	13	38
80116226	13/16 "	30	30	13	38
80116228	7/8 "	30	32	13	38
80116230	15/16 "	30	34	13	38
80116232	1 "	30	37	14	38
80116234	1-1/16 "	30	38	16	40
80116236	1-1/8 "	30	40	16	40
80116238	1-3/16 "	30	42	16	40
80116240	1-1/4 "	30	44	18	40
80116242	1-5/16 "	38	45	21	43
80116244	1-3/8 "	38	48.5	26	50
80116246	1-7/16 "	38	50.5	26	50
80116248	1-1/2 "	38	52.5	26	50

Order No.	Size mm	D2 mm	D1 mm	L2 mm	L mm
80116106	6	25	11	5	38
80116107	7	25	13	5	38
80116108	8	25	14	8	38
80116109	9	25	15	9	38
80116110	10	25	16	10	38
80116111	11	25	18	10	38
80116112	12	25	19	12	38
80116113	13	25	20	12	38
80116114	14	25	22	12	38
80116115	15	25	23	12	38
80116116	16	25	25	12	38
80116117	17	26	26	13	38
80116118	18	27	27	13	38
80116119	19	28	28	13	38
80116120	20	30	30	13	38
80116121	21	30	31	13	38
80116122	22	30	32	13	38
80116123	23	30	32	13	38
80116124	24	30	35	20	45
80116125	25	30	36	20	45
80116126	26	30	38	20	50
80116127	27	30	39	20	50
80116128	28	30	40	20	50
80116129	29	30	41	20	50
80116130	30	30	42	20	50
80116131	31	30	43	22	50
80116132	32	30	44	22	50
80116134	34	30	48	22	50
80116136	36	30	50	24	50
80116138	38	38	53	24	50

# NORMECO INDUSTRIAL SOCKETS



## 六角薄壁标准套筒 6-Point Sockets-With Thin Wall

 1/2" Square Drive
  6-Point Sockets

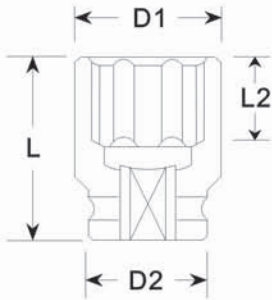

Order No.	Size inch	D2 mm	D1 mm	L2 mm	L mm
80306010	5/16"	25	13	6	38
80306012	3/8"	25	15	6	38
80306014	7/16"	25	17	8	38
80306016	1/2"	25	18.7	9	38
80306018	9/16"	25	21	11	38
80306020	5/8"	28	23	11	38
80306022	11/16"	30	24.5	11	38
80306024	3/4"	30	26	13	38
80306026	13/16"	30	28	15	38
80306028	7/8"	30	30	15	38
80306030	15/16"	30	32	18	45
80306032	1"	30	34	18	50
80306034	1-1/16"	30	36	19	50
80306036	1-1/8"	30	38	19	50
80306038	1-3/16"	30	40	21	50
80306040	1-1/4"	30	42	22	50

Order No.	Size mm	D2 mm	D1 mm	L2 mm	L mm
80305008	8	25	13	6	38
80305009	9	25	14.5	6	38
80305010	10	25	15.5	7	38
80305011	11	25	16.7	8	38
80305012	12	25	18	9	38
80305013	13	25	19.2	9	38
80305014	14	25	21	11	38
80305015	15	25	21.7	11	38
80305016	16	25	23	11	38
80305017	17	25	24	11	38
80305018	18	25	25	13	38
80305019	19	26	26	13	38
80305020	20	27.5	27.5	13	38
80305021	21	28	28	13	38
80305022	22	29.5	29.5	13	38
80305023	23	30	30.5	13	38
80305024	24	30	32	18	45
80305025	25	30	33	18	45
80305026	26	30	35	18	50
80305027	27	30	36	19	50
80305028	28	30	37.5	19	50
80305029	29	30	38.5	19	50
80305030	30	30	40	21	50
80305031	31	30	41	21	50
80305032	32	30	42	22	50

	1/4"
P1-10	
	3/8"
P11-44	
	1/2"
P45-92	
	5/8"
P93-94	
	3/4"
P95-112	
	1"
P113-128	
	1-1/2"
P129-132	
	2-1/2"
P133-136	
	起子套筒
P137-145	
	起子头
P146-164	

仅适用于狭窄工位常规扭矩环境。  
 Access in narrow space application at low torque range.



# NORMECO INDUSTRIAL SOCKETS

- 1/4"
- P1-10
- 3/8"
- P11-44
- 1/2"
- P45-92
- 5/8"
- P93-94
- 3/4"
- P95-112
- 1"
- P113-128
- 1-1/2"
- P129-132
- 2-1/2"
- P133-136
- 起子套筒
- P137-145
- 起子头
- P146-164

## 六角固定磁标准套筒 6-Point Sockets-With Fixed Magnet

1/2" Square Drive 6-Point Sockets

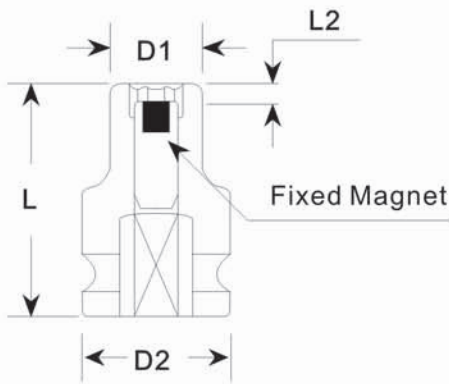

Order No.	Size inch	D2 mm	D1 mm	L2 mm	L mm
80269010	5/16 "	25	15	3.5	38
80269012	3/8 "	25	16	4	38
80269014	7/16 "	25	19	5	38
80269016	1/2 "	25	20	5	38
80269018	9/16 "	25	23	6	38
80269020	5/8 "	25	25	6	38
80269022	11/16 "	30	27	6	38
80269024	3/4 "	30	29	7	38
80269026	13/16 "	30	31	8	38
80269028	7/8 "	30	33	8	38
80269030	15/16 "	30	35	10	45
80269032	1 "	30	37	10	45

Order No.	Size mm	D2 mm	D1 mm	L2 mm	L mm
80268008	8	25	14	3.5	38
80268009	9	25	16	4	38
80268010	10	25	16	4	38
80268011	11	25	18	5	38
80268012	12	25	19	5	38
80268013	13	25	20	5	38
80268014	14	25	22	6	38
80268015	15	25	23	6	38
80268016	16	25	25	6	38
80268017	17	26	26	6	38
80268018	18	27	27	7	38
80268019	19	28	28	7	38
80268020	20	30	30	7	38
80268021	21	30	31	9	38
80268022	22	30	32	9	38
80268024	24	30	35	10	45



## 六角重工型套筒 6-Point Heavy Duty Sockets

1/2" Square Drive 6-Point Sockets

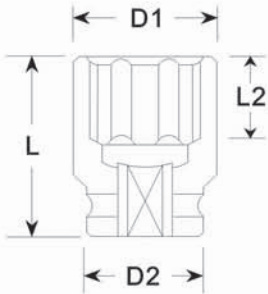

Order No.	Size mm	D2 mm	D1 mm	L2 mm	L mm
80116508	8	25	15	8	38
80116509	9	25	16	9	38
80116510	10	25	17.5	10	38
80116511	11	25	18.5	10	38
80116512	12	25	20	12	38
80116513	13	25	21	12	38
80116514	14	25	23	12	38
80116515	15	30	24	12	38
80116516	16	30	26	12	38
80116517	17	30	27	13	38
80116518	18	30	28	13	38
80116519	19	30	29	13	38
80116520	20	30	31	13	38
80116521	21	30	33	13	38

## 六角半加长套筒 6-Point Sockets-Semi Deep length

1/2" Square Drive 6-Point Sockets

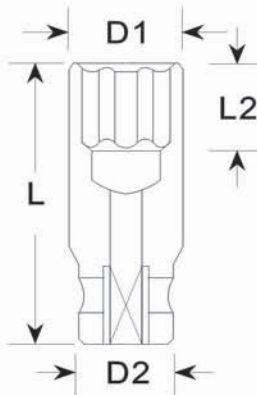

Order No.	Size inch	D2 mm	D1 mm	L2 mm	L mm
80118010	5/16 "	25	14	10	52
80118012	3/8 "	25	15	12	52
80118014	7/16 "	25	16	14	52
80118016	1/2 "	25	20	14	52
80118018	9/16 "	25	22	14	52
80118020	5/8 "	25	25	17	52
80118022	11/16 "	26	26	18	52
80118024	3/4 "	30	28	19	52
80118026	13/16 "	30	30	24	52
80118028	7/8 "	30	32	24	52
80118030	15/16 "	30	35	24	52
80118032	1 "	30	36	24	52



Order No.	Size mm	D2 mm	D1 mm	L2 mm	L mm
80118108	8	25	14	10	52
80118109	9	25	15	10	52
80118110	10	25	16	12	52
80118111	11	25	17.5	12	52
80118112	12	25	19	14	52
80118113	13	25	20	14	52
80118114	14	25	22	16	52
80118115	15	25	23	16	52
80118116	16	25	25	17	52
80118117	17	26	26	17	52
80118118	18	27	27	18	52
80118119	19	28	28	19	52
80118120	20	29	29	20	52
80118121	21	30	31	21	52
80118122	22	30	32	22	52
80118123	23	30	32	24	52
80118124	24	30	35	24	52



# NORMECO INDUSTRIAL SOCKETS

1/4"	P1-10
3/8"	P11-44
1/2"	P45-92
5/8"	P93-94
3/4"	P95-112
1"	P113-128
1-1/2"	P129-132
2-1/2"	P133-136
起子套筒	P137-145
起子头	P146-164

## 六角加长套筒 6-Point Sockets-Deep length

 1/2" Square Drive
  6-Point Sockets

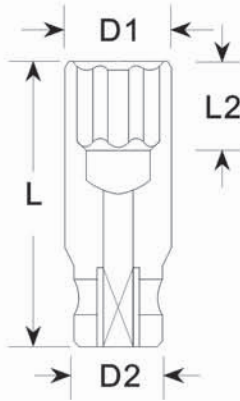

Order No.	Size inch	D2 mm	D1 mm	L2 mm	L mm
80118610	5/16"	25	15	12	78
80118612	3/8"	25	16	12	78
80118614	7/16"	25	18	13	78
80118616	1/2"	25	21	14	78
80118618	9/16"	25	22	17	78
80118620	5/8"	25	24	17	78
80118622	11/16"	26	26	17	78
80118624	3/4"	30	28	19	78
80118626	13/16"	30	30	24	78
80118628	7/8"	30	32	24	78
80118630	15/16"	30	34	24	78
80118632	1"	30	36	24	78
80118634	1-1/16"	30	38	24	78
80118636	1-1/8"	30	40	54	78
80118638	1-3/16"	30	42	54	78
80118640	1-1/4"	30	44	54	78
80118642	1-5/16"	30	45	54	78
80118644	1-3/8"	30	48.5	54	78
80118646	1-7/16"	30	50.5	54	78
80118648	1-1/2"	30	52.5	54	78



Order No.	Size mm	D2 mm	D1 mm	L2 mm	L mm
80118508	8	25	15	12	78
80118509	9	25	16	12	78
80118510	10	25	17	12	78
80118511	11	25	18.7	13	78
80118512	12	25	20	13	78
80118513	13	25	21	14	78
80118514	14	25	22	15	78
80118515	15	30	23	16	78
80118516	16	30	25	17	78
80118517	17	30	26	17	78
80118518	18	30	27	17	78
80118519	19	30	28.7	19	78
80118520	20	30	30	19	78
80118521	21	30	31	21	78
80118522	22	30	32	22	78
80118523	23	30	34	24	78
80118524	24	30	35	24	78
80118527	27	30	38	27	78
80118530	30	30	42	27	78
80118532	32	30	44	27	78
80118534	34	30	48	36	90



# NORMECO INDUSTRIAL SOCKETS



## 六角薄壁加长套筒 6-Point Sockets-Thin Wall Deep length

 1/2" Square Drive
  6-Point Sockets

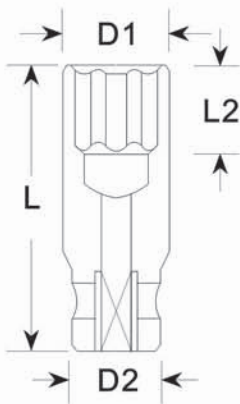

Order No.	Size inch	D2 mm	D1 mm	L2 mm	L mm
80308010	5/16"	25	13	13	78
80308012	3/8"	25	15	14	78
80308014	7/16"	25	17	14	78
80308016	1/2"	25	18.7	14	78
80308018	9/16"	25	21	17	78
80308020	5/8"	28	23	17	78
80308022	11/16"	30	24.5	17	78
80308024	3/4"	30	26	19	78
80308026	13/16"	30	28	24	78
80308028	7/8"	30	30	24	78
80308030	15/16"	30	32	24	78
80308032	1"	30	34	24	78
80308034	1-1/16"	30	36	24	78
80308036	1-1/8"	30	38	24	78
80308038	1-3/16"	30	40	24	78
80308040	1-1/4"	30	42	24	78

Order No.	Size mm	D2 mm	D1 mm	L2 mm	L mm
80307008	8	25	13	13	78
80307009	9	25	14.5	14	78
80307010	10	25	15.5	14	78
80307011	11	25	16.7	14	78
80307012	12	25	18	14	78
80307013	13	25	19.2	14	78
80307014	14	25	21	15	78
80307015	15	30	21.7	15	78
80307016	16	30	23	16	78
80307017	17	30	24	17	78
80307018	18	30	25	17	78
80307019	19	30	26	19	78
80307020	20	30	27.5	20	78
80307021	21	30	28	21	78
80307022	22	30	29.5	22	78
80307023	23	30	30.5	24	78
80307024	24	30	32	24	78
80307027	27	30	36	24	78
80307030	30	30	40	24	78
80307032	32	30	42	24	78



仅适用于狭窄工位常规扭矩环境。  
Access in narrow space application at low torque range.

1/4"

P1-10

3/8"

P11-44

1/2"

P45-92

5/8"

P93-94

3/4"

P95-112

1"

P113-128

1-1/2"

P129-132

2-1/2"

P133-136

起子套筒

P137-145

起子头

P146-164



# NORMECO INDUSTRIAL SOCKETS

- 1/4"
- P1-10
- 3/8"
- P11-44
- 1/2"
- P45-92
- 5/8"
- P93-94
- 3/4"
- P95-112
- 1"
- P113-128
- 1-1/2"
- P129-132
- 2-1/2"
- P133-136
- 起子套筒
- P137-145
- 起子头
- P146-164

## 六角伸缩磁加长套筒 6-Point Sockets-With Sliding Magnet

1/2" Square Drive 6-Point Sockets

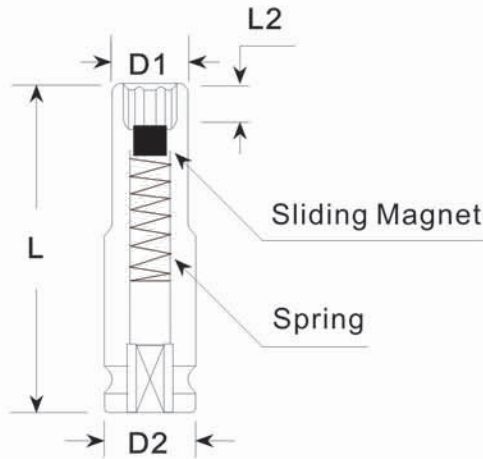

Order No.	Size inch	D2 mm	D1 mm	L2 mm	L mm
80273010	5/16"	25	15	3.5	78
80273012	3/8"	25	17.5	4	78
80273014	7/16"	25	19	5	78
80273016	1/2"	25	21	5	78
80273018	9/16"	25	23	6	78
80273020	5/8"	30	25	6	78
80273022	11/16"	30	27	6	78
80273024	3/4"	30	28	7	78
80273026	13/16"	30	31	8	78
80273028	7/8"	30	33	8	78
80273030	15/16"	30	35	10	78
80273032	1"	30	37	10	78

Order No.	Size mm	D2 mm	D1 mm	L2 mm	L mm
80271008	8	25	15	3.5	78
80271009	9	25	16	4	78
80271010	10	25	17	4	78
80271011	11	25	18.7	5	78
80271012	12	25	20	5	78
80271013	13	25	21	5	78
80271014	14	25	22	6	78
80271015	15	30	23	6	78
80271016	16	30	25	6	78
80271017	17	30	26	6	78
80271018	18	30	27	7	78
80271019	19	30	28	7	78
80271020	20	30	30	7	78
80271021	21	30	31	10	78
80271022	22	30	32	11	78
80271024	24	30	35	13	78



## 六角薄壁特长套筒

6-Point Sockets-Extral Deep length & Thin Wall

 1/2" Square Drive
  6-Point Sockets

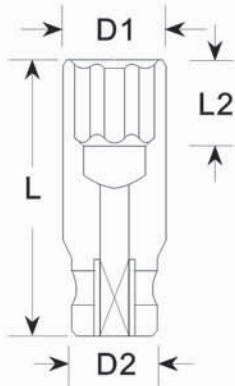

Order No.	Size mm	D2 mm	D1 mm	L2 mm	L mm
80118810	5/16"	24	15	13	127
80118812	3/8"	24	16	14	127
80118814	7/16"	24	18	14	127
80118816	1/2"	24	20	14	127
80118818	9/16"	24	22	24	127
80118820	5/8"	24	24	24	127
80118822	11/16"	26	26	24	127
80118824	3/4"	28	28	24	127
80118826	13/16"	30	30	24	127
80118828	7/8"	32	32	24	127
80118830	15/16"	34	34	24	127
80118832	1"	36	36	24	127
80118834	1-1/16"	38	38	24	127
80118836	1-1/8"	38	40	24	127
80118838	1-3/16"	38	42	24	127
80118840	1-1/4"	38	44	24	127
80118842	1-5/16"	38	46	24	127
80118844	1-3/8"	38	48	24	127
80118846	1-7/16"	38	50	24	127
80118848	1-1/2"	38	52	24	127

Order No.	Size mm	D2 mm	D1 mm	L2 mm	L mm
80118908	8	25	15	12	127
80118909	9	25	15	12	127
80118910	10	25	17	12	127
80118911	11	25	18	14	127
80118912	12	25	19	14	127
80118913	13	25	20	14	127
80118914	14	25	22	17	127
80118915	15	25	24	17	127
80118916	16	25	25	17	127
80118917	17	25	25	17	127
80118918	18	25	26	17	127
80118919	19	25	28	19	127
80118920	20	30	30	19	127
80118921	21	30	31	21	127
80118922	22	30	32	22	127
80118923	23	30	32	24	127
80118924	24	30	35	24	127
80118927	27	30	38	27	127
80118930	30	30	42	27	127
80118932	32	30	44	27	127

1/4"

P1-10

3/8"

P11-44

1/2"

P45-92

5/8"

P93-94

3/4"

P95-112

1"

P113-128

1-1/2"

P129-132

2-1/2"

P133-136

起子套筒

P137-145

起子头

P146-164

仅适用于狭窄工位常规扭矩环境。  
Access in narrow space application at low torque range.



# NORMECO INDUSTRIAL SOCKETS

- 1/4"
- P1-10
- 3/8"
- P11-44
- 1/2"
- P45-92
- 5/8"
- P93-94
- 3/4"
- P95-112
- 1"
- P113-128
- 1-1/2"
- P129-132
- 2-1/2"
- P133-136
- 起子套筒
- P137-145
- 起子头
- P146-164

## 六角接杆套筒 6-Point Sockets-Extended length

1/2" Square Drive 6-Point Sockets



Order No.	Size mm	D2 mm	D1 mm	L2 mm	L mm
80120A08	8	25	15	10	125
80120A10	10	25	17	10	125
80120A12	12	25	19.5	12	125
80120A13	13	25	21	12	125
80120A14	14	25	22	12	125
80120A15	15	25	23	12	125
80120A16	16	25	25	13	125
80120A17	17	25	26	13	125
80120A18	18	25	27	13	125
80120A19	19	30	28	13	125
80120A21	21	30	31	13	125
80120A22	22	30	32	14	125
80120A23	23	30	34	14	125
80120A24	24	30	35	15	125

Order No.	Size mm	D2 mm	D1 mm	L2 mm	L mm
80120B08	8	25	15	10	150
80120B10	10	25	17	10	150
80120B12	12	25	19.5	12	150
80120B13	13	25	21	12	150
80120B14	14	25	22	12	150
80120B15	15	25	23	12	150
80120B16	16	25	25	13	150
80120B17	17	25	26	13	150
80120B18	18	25	27	13	150
80120B19	19	30	28	13	150
80120B21	21	30	31	13	150
80120B22	22	30	32	14	150
80120B23	23	30	34	14	150
80120B24	24	30	35	15	150

Order No.	Size mm	D2 mm	D1 mm	L2 mm	L mm
80120C08	8	25	15	10	175
80120C10	10	25	17	10	175
80120C12	12	25	19.5	12	175
80120C13	13	25	21	12	175
80120C14	14	25	22	12	175
80120C15	15	25	23	12	175
80120C16	16	25	25	13	175
80120C17	17	25	26	13	175
80120C18	18	25	27	13	175
80120C19	19	30	28	13	175
80120C21	21	30	31	13	175
80120C22	22	30	32	14	175
80120C23	23	30	34	14	175
80120C24	24	30	35	15	175

Order No.	Size mm	D2 mm	D1 mm	L2 mm	L mm
80120D08	8	25	15	10	200
80120D10	10	25	17	10	200
80120D12	12	25	19.5	12	200
80120D13	13	25	21	12	200
80120D14	14	25	22	12	200
80120D15	15	25	23	12	200
80120D16	16	25	25	13	200
80120D17	17	25	26	13	200
80120D18	18	25	27	13	200
80120D19	19	30	28	13	200
80120D21	21	30	31	13	200
80120D22	22	30	32	14	200
80120D23	23	30	34	14	200
80120D24	24	30	35	15	200

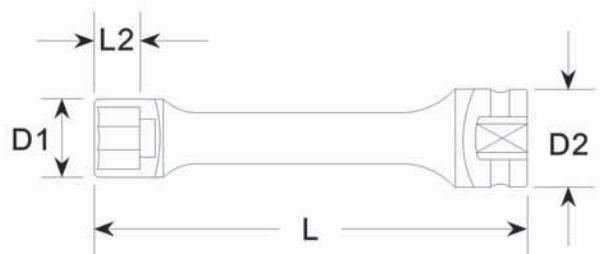

Order No.	Size mm	D2 mm	D1 mm	L2 mm	L mm
80120E08	8	25	15	10	250
80120E10	10	25	17	10	250
80120E12	12	25	19.5	12	250
80120E13	13	25	21	12	250
80120E14	14	25	22	12	250
80120E15	15	25	23	12	250
80120E16	16	25	25	13	250
80120E17	17	25	26	13	250
80120E18	18	25	27	13	250
80120E19	19	30	28	13	250
80120E21	21	30	31	13	250
80120E22	22	30	32	14	250
80120E23	23	30	34	14	250
80120E24	24	30	35	15	250



# NORMECO INDUSTRIAL SOCKETS



## 六角固定磁接杆套筒 6-Point Sockets-Extended length-With Fixed Magnet

 1/2" Square Drive
  6-Point Sockets



Order No.	Size mm	D2 mm	D1 mm	L2 mm	L mm
80275A08	8	25	15	4	125
80275A10	10	25	17	4	125
80275A12	12	25	19.5	5	125
80275A13	13	25	21	5	125
80275A14	14	25	22	6	125
80275A15	15	25	23	7	125
80275A16	16	25	25	7	125
80275A17	17	25	26	8	125
80275A18	18	25	27	8	125
80275A19	19	30	28	8	125
80275A21	21	30	31	9	125
80275A22	22	30	32	9	125
80275A23	23	30	34	9	125
80275A24	24	30	35	10	125

Order No.	Size mm	D2 mm	D1 mm	L2 mm	L mm
80275B08	8	25	15	4	150
80275B10	10	25	17	4	150
80275B12	12	25	19.5	5	150
80275B13	13	25	21	5	150
80275B14	14	25	22	6	150
80275B15	15	25	23	7	150
80275B16	16	25	25	7	150
80275B17	17	25	26	8	150
80275B18	18	25	27	8	150
80275B19	19	30	28	8	150
80275B21	21	30	31	9	150
80275B22	22	30	32	9	150
80275B23	23	30	34	9	150
80275B24	24	30	35	10	150

Order No.	Size mm	D2 mm	D1 mm	L2 mm	L mm
80275C08	8	25	15	4	175
80275C10	10	25	17	4	175
80275C12	12	25	19.5	5	175
80275C13	13	25	21	5	175
80275C14	14	25	22	6	175
80275C15	15	25	23	7	175
80275C16	16	25	25	7	175
80275C17	17	25	26	8	175
80275C18	18	25	27	8	175
80275C19	19	30	28	8	175
80275C21	21	30	31	9	175
80275C22	22	30	32	9	175
80275C23	23	30	34	9	175
80275C24	24	30	35	10	175

Order No.	Size mm	D2 mm	D1 mm	L2 mm	L mm
80275D08	8	25	15	4	200
80275D10	10	25	17	4	200
80275D12	12	25	19.5	5	200
80275D13	13	25	21	5	200
80275D14	14	25	22	6	200
80275D15	15	25	23	7	200
80275D16	16	25	25	7	200
80275D17	17	25	26	8	200
80275D18	18	25	27	8	200
80275D19	19	30	28	8	200
80275D21	21	30	31	9	200
80275D22	22	30	32	9	200
80275D23	23	30	34	9	200
80275D24	24	30	35	10	200

Order No.	Size mm	D2 mm	D1 mm	L2 mm	L mm
80275E08	8	25	15	4	250
80275E10	10	25	17	4	250
80275E12	12	25	19.5	5	250
80275E13	13	25	21	5	250
80275E14	14	25	22	6	250
80275E15	15	25	23	7	250
80275E16	16	25	25	7	250
80275E17	17	25	26	8	250
80275E18	18	25	27	8	250
80275E19	19	30	28	8	250
80275E21	21	30	31	9	250
80275E22	22	30	32	9	250
80275E23	23	30	34	9	250
80275E24	24	30	35	10	250

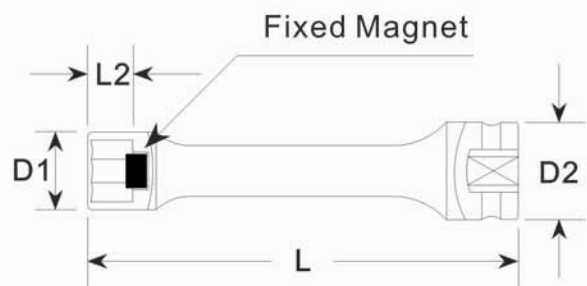

1/4"

P1-10

3/8"

P11-44

1/2"

P45-92

5/8"

P93-94

3/4"

P95-112

1"

P113-128

1-1/2"

P129-132

2-1/2"

P133-136

起子套筒

P137-145

起子头

P146-164



# NORMECO INDUSTRIAL SOCKETS

- 1/4"
- P1-10
- 3/8"
- P11-44
- 1/2"
- P45-92
- 5/8"
- P93-94
- 3/4"
- P95-112
- 1"
- P113-128
- 1-1/2"
- P129-132
- 2-1/2"
- P133-136
- 起子套筒
- P137-145
- 起子头
- P146-164

## ▶ 抗震动套筒 6-Point Anti-vibration Sockets



Order No.	Size mm	D2 mm	D1 mm	L2 mm	L mm
80886108	8	25	14	9	52
80886109	9	25	16	12	52
80886110	10	25	16	12	52
80886111	11	25	18.7	12	52
80886112	12	25	19	12	52
80886113	13	25	20	12	52
80886114	14	25	22	12	52
80886115	15	25	23	12	52
80886116	16	25	25	12	52
80886117	17	30	26	13	52
80886118	18	30	27	13	52
80886119	19	30	28.5	13	52
80886120	20	30	30	14	52
80886121	21	30	31	14	52
80886122	22	30	32	14	52
80886123	23	30	33	14	52
80886124	24	30	35	15	52
80886125	25	30	36	15	57
80886126	26	30	38	17	57
80886127	27	30	38	17	57
80886128	28	30	40	17	57
80886129	29	30	40	18	57
80886130	30	30	41	18	57
80886131	31	30	43	18	57
80886132	32	30	44	18	62

Order No.	Size mm	D2 mm	D1 mm	L2 mm	L mm
80886240	1-1/4"	30	44	22	60

## ▶ 抗震动固定磁套筒 6-Point Anti-vibration Sockets With Fixed Magnet

1/2" Square Drive 6-Point Sockets

注：1、动力工具轴直径16mm。  
2、□□套筒六角对边尺寸。

Remarks: 1. Power tools drive shaft dia 16mm.  
2. □□ hex AF size.

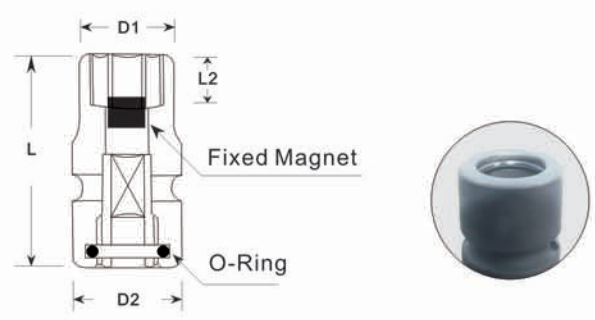

Order No.	Size mm	D2 mm	D1 mm	L2 mm	L mm
808861□□ FM	□□	808861□□	808861□□	802680□□	43





## ▶ 抗震动加长套筒

6-Point Anti-vibration Sockets With Deep Length

1/2" Square Drive 6-Point Sockets



Order No.	Size mm	D2 mm	D1 mm	L2 mm	L mm
80886508	8	25	14	9	100
80886509	9	25	16	12	100
80886510	10	25	16	12	100
80886511	11	25	18.7	12	100
80886512	12	25	19	12	100
80886513	13	25	20	12	100
80886514	14	25	22	12	100
80886515	15	25	23	12	100
80886516	16	25	25	12	100
80886517	17	30	26	13	100
80886518	18	30	27	13	100
80886519	19	30	28.5	13	100
80886520	20	30	30	14	100
80886521	21	30	31	14	100
80886522	22	30	32	14	100
80886523	23	30	32	14	100
80886524	24	30	35	15	100
80886525	25	30	36	15	100
80886526	26	30	38	17	100
80886527	27	30	38	17	100
80886528	28	30	40	17	100
80886529	29	30	40	18	100
80886530	30	30	41	18	100
80886531	31	30	43	18	100
80886532	32	30	44	18	100

## ▶ 抗震动伸缩磁套筒

6-Point Anti-vibration Sockets With Sliding Magnet

1/2" Square Drive 6-Point Sockets

注：1、动力工具轴直径16mm。  
2、□□套筒六角对边尺寸。

Remarks: 1. Power tools drive shaft dia 16mm.  
2. □□ hex AF size.

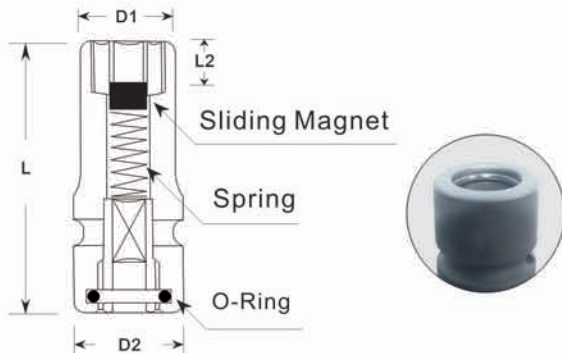

Order No.	Size mm	D2 mm	D1 mm	L2 mm	L mm
808865□□SM □□	808865□□	808865□□	802710□□	100	



- 1/4"
- P11-10
- 3/8"
- P11-44
- 1/2"
- P45-92
- 5/8"
- P93-94
- 3/4"
- P95-112
- 1"
- P113-128
- 1-1/2"
- P129-132
- 2-1/2"
- P133-136
- 起子套筒
- P137-145
- 起子头
- P146-164



# NORMECO INDUSTRIAL SOCKETS

- 1/4"
- P1-10
- 3/8"
- P11-44
- 1/2"
- P45-92
- 5/8"
- P93-94
- 3/4"
- P95-112
- 1"
- P113-128
- 1-1/2"
- P129-132
- 2-1/2"
- P133-136
- 起子套筒
- P137-145
- 起子头
- P146-164

## ▶ 抗震动接杆套筒

6-Point Anti-vibration & Extended Length Sockets

1/2" Square Drive      6-Point Sockets

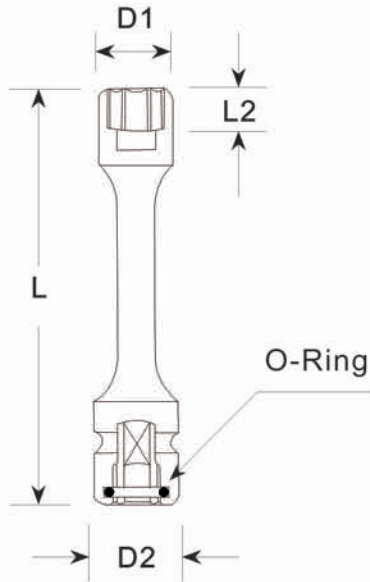

Order No.	Size mm	D2 mm	D1 mm	L2 mm	L mm
80887A08	8	25	15	10	100
80887A10	10	25	17	12	100
80887A12	12	25	19.5	12	100
80887A13	13	25	21	12	100
80887A14	14	25	22	12	100
80887A15	15	25	23	12	100
80887A16	16	25	25	13	100
80887A17	17	25	26	13	100
80887A18	18	25	27	13	100
80887A19	19	25	28	13	100
80887A21	21	25	31	13	100
80887A22	22	25	32	14	100
80887A23	23	25	34	14	100
80887A24	24	30	35	15	100

Order No.	Size mm	D2 mm	D1 mm	L2 mm	L mm
80887B08	8	25	15	10	150
80887B10	10	25	17	12	150
80887B12	12	25	19.5	12	150
80887B13	13	25	21	12	150
80887B14	14	25	22	12	150
80887B15	15	25	23	12	150
80887B16	16	25	25	13	150
80887B17	17	25	26	13	150
80887B18	18	25	27	13	150
80887B19	19	25	28	13	150
80887B21	21	25	31	13	150
80887B22	22	25	32	14	150
80887B23	23	25	34	14	150
80887B24	24	30	35	15	150

Order No.	Size mm	D2 mm	D1 mm	L2 mm	L mm
80887D08	8	25	15	10	200
80887D10	10	25	17	12	200
80887D12	12	25	19.5	12	200
80887D13	13	25	21	12	200
80887D14	14	25	22	12	200
80887D15	15	25	23	12	200
80887D16	16	25	25	13	200
80887D17	17	25	26	13	200
80887D18	18	25	27	13	200
80887D19	19	25	28	13	200
80887D21	21	25	31	13	200
80887D22	22	25	32	14	200
80887D23	23	25	34	14	200
80887D24	24	30	35	15	200



## ▶ 抗震固定磁接杆套筒

6-Point Anti-vibration & Extended Length Sockets With Fixed Magnet

1/2" Square Drive 6-Point Sockets

注：1、动力工具轴直径16mm。

2、□□套筒六角对边尺寸。

attention:1.Power tools drive shaft dia 16mm.

2.□□ hex AF size.

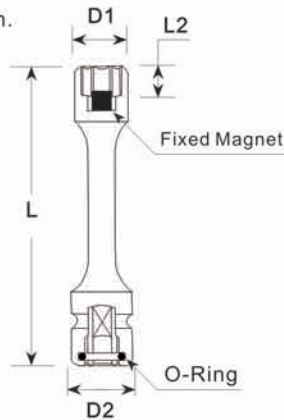

Order No.	Size mm	D2 mm	D1 mm	L2 mm	L mm
80887A□□ FM	□□	80887A□□	80887A□□	80275A□□	100
80887B□□ FM	□□	80887B□□	80887B□□	80275B□□	150
80887D□□ FM	□□	80887D□□	80887D□□	80275D□□	200

## ▶ 六角万向标准套筒 6-Point Universal Sockets

1/2" Square Drive 6-Point Sockets Universal

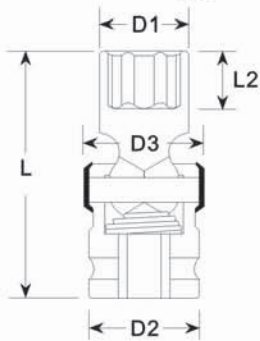

Order No.	Size inch	D3 mm	D2 mm	D1 mm	L2 mm	L mm
80359012	3/8"	31	25	15	10	65
80359014	7/16"	31	25	17	14	65
80359016	1/2"	31	25	19	14	65
80359018	9/16"	31	25	22	14	65
80359020	5/8"	31	25	23	14	65
80359022	11/16"	34	30	26	14	65
80359024	3/4"	34	30	28	14	65
80359026	13/16"	34	30	30	14	65
80359028	7/8"	34	30	32	14	65
80359030	15/16"	34	30	34	14	65

Order No.	Size mm	D3 mm	D2 mm	D1 mm	L2 mm	L mm
80358010	10	31	25	15	10	65
80358011	11	31	25	17	10	65
80358012	12	31	25	19	12	65
80358013	13	31	25	20	12	65
80358014	14	31	25	22	14	65
80358015	15	31	25	23	14	65
80358016	16	31	25	24	14	65
80358017	17	34	30	26	14	65
80358018	18	34	30	27	14	65
80358019	19	34	30	28	14	65
80358020	20	34	30	30	14	65
80358021	21	34	30	31	14	65
80358022	22	34	30	32	14	65
80358023	23	34	30	32	14	65
80358024	24	34	30	35	14	65

1/4"

P1-10

3/8"

P11-44

1/2"

P45-92

5/8"

P93-94

3/4"

P95-112

1"

P113-128

1-1/2"

P129-132

2-1/2"

P133-136

起子套筒

P137-145

起子头

P146-164



# NORMECO INDUSTRIAL SOCKETS

1/4"
P1-10
3/8"
P11-44
1/2"
P45-92
5/8"
P93-94
3/4"
P95-112
1"
P113-128
1-1/2"
P129-132
2-1/2"
P133-136
起子套筒
P137-145
起子头
P146-164

## 六角万向加长套筒 6-Point Universal-Deep length

1/2" Square Drive 6-Point Sockets Universal

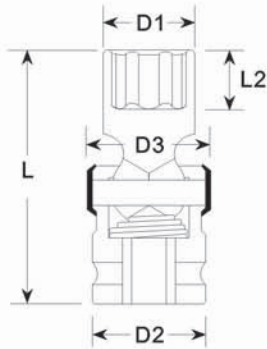

Order No.	Size inch	D3 mm	D2 mm	D1 mm	L2 mm	L mm
80362012	3/8"	31	25	15	14	90
80362014	7/16"	31	25	17	14	90
80362016	1/2"	31	25	19	14	90
80362018	9/16"	31	25	22	14	90
80362020	5/8"	31	25	23	14	90
80362022	11/16"	34	30	26	14	90
80362024	3/4"	34	30	28	14	90
80362026	13/16"	34	30	30	14	90
80362028	7/8"	34	30	32	14	90
80362030	15/16"	34	30	34	14	90

Order No.	Size mm	D3 mm	D2 mm	D1 mm	L2 mm	L mm
80361010	10	31	25	15	14	90
80361011	11	31	25	17	14	90
80361012	12	31	25	19	14	90
80361013	13	31	25	20	14	90
80361014	14	31	25	22	14	90
80361015	15	31	25	23	14	90
80361016	16	31	25	24	14	90
80361017	17	34	30	26	14	90
80361018	18	34	30	27	14	90
80361019	19	34	30	28	14	90
80361020	20	34	30	30	14	90
80361021	21	34	30	31	14	90
80361022	22	34	30	32	14	90
80361023	23	34	30	32	14	90
80361024	24	34	30	35	14	90

# NORMECO INDUSTRIAL SOCKETS



## 六角万向接杆套筒 6-Point Universal Extension



1/2" Square Drive



6-Point Sockets Universal

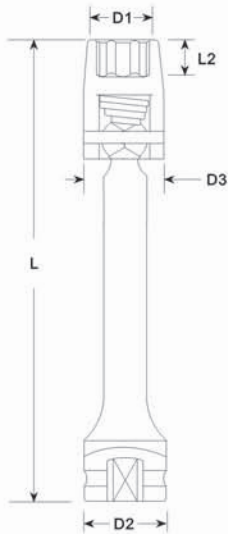

Order No.	Size mm	D3 mm	D2 mm	D1 mm	L2 mm	L mm
80363A08	8	18	25	14	8	100
80363A10	10	19	25	15	9	100
80363A12	12	20.5	25	18	11	100
80363A13	13	21.5	25	19	11	100
80363A14	14	22.5	25	21	11	100
80363A15	15	24	25	22	11	100
80363A16	16	25	25	23	11	100
80363A17	17	26	25	26	13	100
80363A18	18	27	25	27	13	100
80363A19	19	28	25	28	13	100

Order No.	Size mm	D3 mm	D2 mm	D1 mm	L2 mm	L mm
80363B08	8	18	25	14	8	150
80363B10	10	19	25	15	9	150
80363B12	12	20.5	25	18	11	150
80363B13	13	21.5	25	19	11	150
80363B14	14	22.5	25	21	11	150
80363B15	15	24	25	22	11	150
80363B16	16	25	25	23	11	150
80363B17	17	26	25	26	13	150
80363B18	18	27	25	27	13	150
80363B19	19	28	25	28	13	150

Order No.	Size mm	D3 mm	D2 mm	D1 mm	L2 mm	L mm
80363D08	8	18	25	14	8	200
80363D10	10	19	25	15	9	200
80363D12	12	20.5	25	18	11	200
80363D13	13	21.5	25	19	11	200
80363D14	14	22.5	25	21	11	200
80363D15	15	24	25	22	11	200
80363D16	16	25	25	23	11	200
80363D17	17	26	25	26	13	200
80363D18	18	27	25	27	13	200
80363D19	19	28	25	28	13	200

Order No.	Size mm	D3 mm	D2 mm	D1 mm	L2 mm	L mm
80363E08	8	18	25	14	8	250
80363E10	10	19	25	15	9	250
80363E12	12	20.5	25	18	11	250
80363E13	13	21.5	25	19	11	250
80363E14	14	22.5	25	21	11	250
80363E15	15	24	25	22	11	250
80363E16	16	25	25	23	11	250
80363E17	17	26	25	26	13	250
80363E18	18	27	25	27	13	250
80363E19	19	28	25	28	13	250



1/4"

P1-10



3/8"

P11-44



1/2"

P45-92



5/8"

P93-94



3/4"

P95-112



1"

P113-128



1-1/2"

P129-132



2-1/2"

P133-136



起子套筒

P137-145

起子头

P146-164



# NORMECO INDUSTRIAL SOCKETS

1/4"	P1-10
3/8"	P11-44
1/2"	P45-92
5/8"	P93-94
3/4"	P95-112
1"	P113-128
1-1/2"	P129-132
2-1/2"	P133-136
起子套筒	P137-145
起子头	P146-164

## 六角万向接杆套筒 6-Point Universal Extension

 1/2" Square Drive
  6-Point Sockets Universal

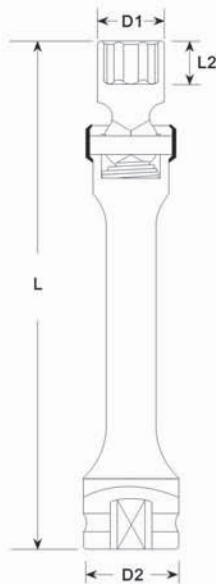

Order No.	Size mm	D3 mm	D2 mm	D1 mm	L2 mm	L mm
80365B08	8	31	25	14	8	150
80365B10	10	31	25	15	9	150
80365B12	12	31	25	18	11	150
80365B13	13	31	25	19	11	150
80365B14	14	31	25	21	11	150
80365B15	15	31	25	22	11	150
80365B16	16	31	25	24	14	150
80365B17	17	34	25	26	14	150
80365B18	18	34	30	26	14	150
80365B19	19	34	30	27	14	150

Order No.	Size mm	D3 mm	D2 mm	D1 mm	L2 mm	L mm
80365D08	8	31	25	14	8	200
80365D10	10	31	25	15	9	200
80365D12	12	31	25	18	11	200
80365D13	13	31	25	19	11	200
80365D14	14	31	25	21	11	200
80365D15	15	31	25	22	11	200
80365D16	16	31	25	24	14	200
80365D17	17	34	25	26	14	200
80365D18	18	34	30	26	14	200
80365D19	19	34	30	27	14	200

Order No.	Size mm	D3 mm	D2 mm	D1 mm	L2 mm	L mm
80365E08	8	31	25	14	8	250
80365E10	10	31	25	15	9	250
80365E12	12	31	25	18	11	250
80365E13	13	31	25	19	11	250
80365E14	14	31	25	21	11	250
80365E15	15	31	25	22	11	250
80365E16	16	31	25	24	14	250
80365E17	17	34	25	26	14	250
80365E18	18	34	30	26	14	250
80365E19	19	34	30	27	14	250



▶ 十二角标准套筒 12-Point Sockets

 1/2" Square Drive
  12-Point Sockets

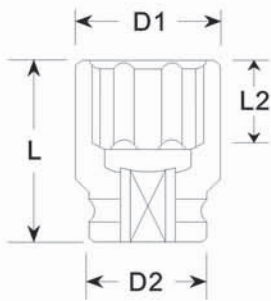

Order No.	Size inch	D2 mm	D1 mm	L2 mm	L mm
80217010	5/16"	25	15	6	38
80217012	3/8"	25	17	6	38
80217014	7/16"	25	19	8	38
80217016	1/2"	25	21	9	38
80217018	9/16"	25	22.5	11	38
80217020	5/8"	28	25	11	38
80217022	11/16"	30	27	11	38
80217024	3/4"	30	29	13	40
80217026	13/16"	30	31	15	40
80217028	7/8"	30	32.5	15	40
80217030	15/16"	30	35	18	45
80217100	1"	30	37	18	45
80217102	1-1/16"	30	39	19	50
80217104	1-1/8"	30	41	19	50
80217106	1-3/16"	30	42.5	21	50
80217108	1-1/4"	30	45	22	50
80217110	1-5/16"	30	46.5	22	50
80217112	1-3/8"	30	49.5	22	50
80217114	1-7/16"	30	51	24	50
80217116	1-1/2"	38	53	24	50

Order No.	Size mm	D2 mm	D1 mm	L2 mm	L mm
80216008	8	25	14	6	38
80216009	9	25	16	6	38
80216010	10	25	17	7	38
80216011	11	25	19	8	38
80216012	12	25	20	9	38
80216013	13	25	21	9	38
80216014	14	25	22.5	11	38
80216015	15	25	23.5	11	38
80216016	16	25	25	11	38
80216017	17	26.5	26.5	11	38
80216018	18	30	27.5	13	40
80216019	19	30	29	13	40
80216020	20	30	30	13	40
80216021	21	30	31	15	40
80216022	22	30	32.5	15	40
80216023	23	30	34	15	40
80216024	24	30	35	18	45
80216025	25	30	36	18	45
80216026	26	30	38	18	50
80216027	27	30	39	19	50
80216028	28	30	40	19	50
80216029	29	30	41	19	50
80216030	30	30	42.5	21	50
80216032	32	30	45	22	50
80216034	34	30	48	22	50
80216036	36	30	50.5	24	50

	1/4"
P1-10	
	3/8"
P11-44	
	1/2"
P45-92	
	5/8"
P93-94	
	3/4"
P95-112	
	1"
P113-128	
	1-1/2"
P129-132	
	2-1/2"
P133-136	
	起子套筒
P137-145	
	起子头
P146-164	



# NORMECO INDUSTRIAL SOCKETS

- 1/4" P1-10
- 3/8" P11-44
- 1/2" P45-92
- 5/8" P93-94
- 3/4" P95-112
- 1" P113-128
- 1-1/2" P129-132
- 2-1/2" P133-136
- 起子套筒 P137-145
- 起子头 P146-164

## 十二角薄壁标准套筒 12-Point Sockets-With Thin Wall

1/2" Square Drive 12-Point Sockets

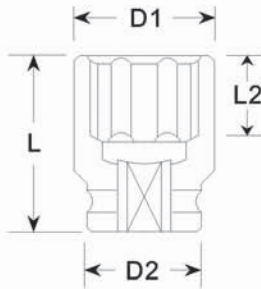

Order No.	Size inch	D2 mm	D1 mm	L2 mm	L mm
80312010	5/16"	25	13	6	38
80312012	3/8"	25	15	6	38
80312014	7/16"	25	17	8	38
80312016	1/2"	25	18.7	9	38
80312018	9/16"	25	21	11	38
80312020	5/8"	28	23	11	38
80312022	11/16"	30	24.5	11	38
80312024	3/4"	30	26	13	40
80312026	13/16"	30	28	15	40
80312028	7/8"	30	30	15	40
80312030	15/16"	30	32	18	45
80312032	1"	30	34	18	45
80312034	1-1/16"	30	36	19	50
80312036	1-1/8"	30	38	19	50
80312038	1-3/16"	30	40	21	50
80312040	1-1/4"	30	42	22	50

Order No.	Size mm	D2 mm	D1 mm	L2 mm	L mm
80310008	8	25	13	6	38
80310009	9	25	14.5	6	38
80310010	10	25	15.5	7	38
80310011	11	25	16.7	8	38
80310012	12	25	18	9	38
80310013	13	25	19.2	9	38
80310014	14	25	21	11	38
80310015	15	25	21.7	11	38
80310016	16	25	23	11	38
80310017	17	25	24	11	38
80310018	18	25	25	13	40
80310019	19	26	26	13	40
80310020	20	30	27.5	15	40
80310021	21	30	28.5	15	40
80310022	22	30	29.5	15	40
80310023	23	30	30.5	15	40
80310024	24	30	32	18	45
80310025	25	30	33	18	50
80310026	26	30	35	19	50
80310027	27	30	36	19	50
80310028	28	30	37.5	19	50
80310029	29	30	38.5	19	50
80310030	30	30	40	21	50
80310031	31	30	41	21	50
80310032	32	30	42	22	50

仅适用于狭窄工位常规扭矩环境。  
Access in narrow space application at low torque range.

# NORMECO INDUSTRIAL SOCKETS



## ▶ 十二角固定磁标准套筒 12-Point Sockets-With Fixed Magnet

 1/2" Square Drive
  12-Point Sockets

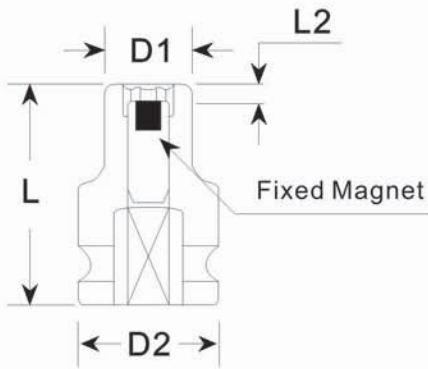

Order No.	Size inch	D2 mm	D1 mm	L2 mm	L mm
80295010	5/16"	25	15	3.5	38
80295012	3/8"	25	17	4	38
80295014	7/16"	25	19	5	38
80295016	1/2"	25	21	5	38
80295018	9/16"	25	22.5	6	38
80295020	5/8"	28	25	6	38
80295022	11/16"	30	27	6	38
80295024	3/4"	30	29	7	40
80295026	13/16"	30	31	8	40
80295028	7/8"	30	32.5	8	40
80295030	15/16"	30	35	10	45
80295032	1"	30	37	10	45

Order No.	Size mm	D2 mm	D1 mm	L2 mm	L mm
80293008	8	25	14	3.5	38
80293009	9	25	16	4	38
80293010	10	25	17.5	4	38
80293011	11	25	18.7	5	38
80293012	12	25	20	5	38
80293013	13	25	21	5	38
80293014	14	25	22.5	6	38
80293015	15	25	23.7	6	38
80293016	16	25	25	6	38
80293017	17	26.5	26.5	6	38
80293018	18	30	27.5	7	40
80293019	19	30	29	7	40
80293020	20	30	30	7	40
80293021	21	30	31	8	40
80293022	22	30	32.5	8	40
80293024	24	30	35	10	45



-  1/4"
- P1-10
-  3/8"
- P11-44
-  1/2"
- P45-92
-  5/8"
- P93-94
-  3/4"
- P95-112
-  1"
- P113-128
-  1-1/2"
- P129-132
-  2-1/2"
- P133-136
-  起子套筒
- P137-145
-  起子头
- P146-164



# NORMECO INDUSTRIAL SOCKETS

- 1/4"
- P1-10
- 3/8"
- P11-44
- 1/2"
- P45-92
- 5/8"
- P93-94
- 3/4"
- P95-112
- 1"
- P113-128
- 1-1/2"
- P129-132
- 2-1/2"
- P133-136
- 起子套筒
- P137-145
- 起子头
- P146-164

## 十二角加长套筒 12-Point Sockets-Deep length

1/2" Square Drive      12-Point Sockets

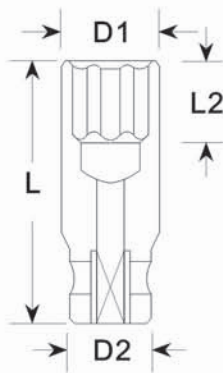

Order No.	Size inch	D2 mm	D1 mm	L2 mm	L mm
80223010	5/16"	25	15	6	83
80223012	3/8"	25	17	6	83
80223014	7/16"	25	19	8	83
80223016	1/2"	25	21	9	83
80223018	9/16"	25	22.5	11	83
80223020	5/8"	28	25	11	83
80223022	11/16"	30	27	11	83
80223024	3/4"	30	29	13	83
80223026	13/16"	30	31	15	83
80223028	7/8"	30	32.5	15	90
80223030	15/16"	30	35	18	90
80223032	1"	30	37	18	90
80223034	1-1/16"	30	39	19	90
80223036	1-1/8"	30	41	19	90
80223038	1-3/16"	30	42.5	21	90
80223040	1-1/4"	30	45	22	90
80223042	1-5/16"	30	46.5	22	90
80223044	1-3/8"	30	49.5	22	90
80223046	1-7/16"	30	51	24	90
80223048	1-1/2"	38	53	24	90

Order No.	Size mm	D2 mm	D1 mm	L2 mm	L mm
80220008	8	25	15	6	83
80220009	9	25	16	6	83
80220010	10	25	17	7	83
80220011	11	25	19	8	83
80220012	12	25	20	9	83
80220013	13	25	21	9	83
80220014	14	25	22.5	11	83
80220015	15	25	23.5	11	83
80220016	16	25	25	11	83
80220017	17	30	26.5	11	83
80220018	18	30	27.5	13	83
80220019	19	30	29	13	83
80220020	20	30	30	13	83
80220021	21	30	31	15	83
80220022	22	30	32.5	15	90
80220023	23	30	34	15	90
80220024	24	30	35	18	90
80220027	27	30	39	19	90
80220030	30	30	42.5	21	90
80220032	32	30	45	22	90

# NORMECO INDUSTRIAL SOCKETS



## 十二角薄壁加长套筒 12-Point Sockets-Thin Wall Deep length

 1/2" Square Drive
  12-Point Sockets

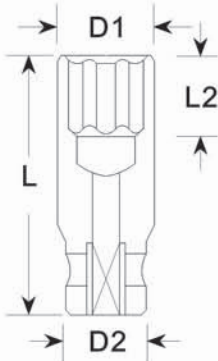

Order No.	Size inch	D2 mm	D1 mm	L2 mm	L mm
80318010	5/16"	25	13	6	83
80318012	3/8"	25	15	6	83
80318014	7/16"	25	17	8	83
80318016	1/2"	25	18.7	9	83
80318018	9/16"	25	21	11	83
80318020	5/8"	28	23	11	83
80318022	11/16"	30	24.5	11	83
80318024	3/4"	30	26	13	83
80318026	13/16"	30	28	15	83
80318028	7/8"	30	30	15	90
80318030	15/16"	30	32	18	90
80318032	1"	30	34	18	90
80318034	1-1/16"	30	36	19	90
80318036	1-1/8"	30	38	19	90
80318038	1-3/16"	30	40	21	90
80318040	1-1/4"	30	42	22	90

Order No.	Size mm	D2 mm	D1 mm	L2 mm	L mm
80316008	8	25	13	6	83
80316009	9	25	14.5	6	83
80316010	10	25	15.5	7	83
80316011	11	25	16.7	8	83
80316012	12	25	18	9	83
80316013	13	25	19.2	9	83
80316014	14	25	21	11	83
80316015	15	25	21.7	11	83
80316016	16	25	23	11	83
80316017	17	25	24	11	83
80316018	18	25	25	13	83
80316019	19	26	26	13	83
80316020	20	30	27.5	15	83
80316021	21	30	28	15	83
80316022	22	30	29.5	15	90
80316023	23	30	30.5	18	90
80316024	24	30	32	18	90
80316027	27	30	36	21	90
80316030	30	30	40	22	90
80316032	32	30	42	22	90

1/4"

P1-10

3/8"

P11-44

1/2"

P45-92

5/8"

P93-94

3/4"

P95-112

1"

P113-128

1-1/2"

P129-132

2-1/2"

P133-136

起子套筒

P137-145

起子头

P146-164

仅适用于狭窄工位常规扭矩环境。  
Access in narrow space application at low torque range.



# NORMECO INDUSTRIAL SOCKETS

- 1/4" P1-10
- 3/8" P11-44
- 1/2" P45-92
- 5/8" P93-94
- 3/4" P95-112
- 1" P113-128
- 1-1/2" P129-132
- 2-1/2" P133-136
- 起子套筒 P137-145
- 起子头 P146-164

## 十二角伸缩磁加长套筒 12-Point Sockets-With Sliding Magnet

1/2" Square Drive 12-Point Sockets

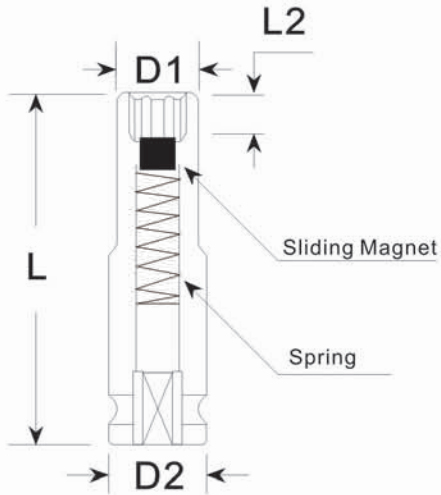

Order No.	Size inch	D2 mm	D1 mm	L2 mm	L mm
80298010	5/16"	25	15	3.5	83
80298012	3/8"	25	17	4	83
80298014	7/16"	25	19	5	83
80298016	1/2"	25	21	5	83
80298018	9/16"	25	22.5	6	83
80298020	5/8"	28	25	6	83
80298022	11/16"	30	27	6	83
80298024	3/4"	30	29	7	83
80298026	13/16"	30	31	8	83
80298028	7/8"	30	32.5	8	83
80298030	15/16"	30	35	10	83
80298032	1"	30	37	10	83

Order No.	Size mm	D2 mm	D1 mm	L2 mm	L mm
80297008	8	25	15	3.5	83
80297009	9	25	16	4	83
80297010	10	25	17.5	4	83
80297011	11	25	19	5	83
80297012	12	25	20	5	83
80297013	13	25	21	5	83
80297014	14	25	22.5	6	83
80297015	15	25	23.5	6	83
80297016	16	25	25	6	83
80297017	17	30	26	6	83
80297018	18	30	27.5	7	83
80297019	19	30	29	7	83
80297020	20	30	30	7	83
80297021	21	30	31	8	83
80297022	22	30	32.5	8	83
80297024	24	30	35	10	83

# NORMECO INDUSTRIAL SOCKETS



## 十二角接杆套筒 12-Point Sockets-Extended length

 1/2" Square Drive
  12-Point Sockets



Order No.	Size mm	D2 mm	D1 mm	L2 mm	L mm
80225A08	8	25	15	10	125
80225A10	10	25	17	10	125
80225A12	12	25	19.5	12	125
80225A13	13	25	21	12	125
80225A14	14	25	22	12	125
80225A15	15	25	23	12	125
80225A16	16	25	25	13	125
80225A17	17	25	26	13	125
80225A18	18	25	27	13	125
80225A19	19	30	28	13	125
80225A21	21	30	31	13	125
80225A22	22	30	32	14	125
80225A23	23	30	34	14	125
80225A24	24	30	35	15	125

Order No.	Size mm	D2 mm	D1 mm	L2 mm	L mm
80225B08	8	25	15	10	150
80225B10	10	25	17	10	150
80225B12	12	25	19.5	12	150
80225B13	13	25	21	12	150
80225B14	14	25	22	12	150
80225B15	15	25	23	12	150
80225B16	16	25	25	13	150
80225B17	17	25	26	13	150
80225B18	18	25	27	13	150
80225B19	19	30	28	13	150
80225B21	21	30	31	13	150
80225B22	22	30	32	14	150
80225B23	23	30	34	14	150
80225B24	24	30	35	15	150

Order No.	Size mm	D2 mm	D1 mm	L2 mm	L mm
80225C08	8	25	15	10	175
80225C10	10	25	17	10	175
80225C12	12	25	19.5	12	175
80225C13	13	25	21	12	175
80225C14	14	25	22	12	175
80225C15	15	25	23	12	175
80225C16	16	25	25	13	175
80225C17	17	25	26	13	175
80225C18	18	25	27	13	175
80225C19	19	30	28	13	175
80225C21	21	30	31	13	175
80225C22	22	30	32	14	175
80225C23	23	30	34	14	175
80225C24	24	30	35	15	175

Order No.	Size mm	D2 mm	D1 mm	L2 mm	L mm
80225D08	8	25	15	10	200
80225D10	10	25	17	10	200
80225D12	12	25	19.5	12	200
80225D13	13	25	21	12	200
80225D14	14	25	22	12	200
80225D15	15	25	23	12	200
80225D16	16	25	25	13	200
80225D17	17	25	26	13	200
80225D18	18	25	27	13	200
80225D19	19	30	28	13	200
80225D21	21	30	31	13	200
80225D22	22	30	32	14	200
80225D23	23	30	34	14	200
80225D24	24	30	35	15	200

Order No.	Size mm	D2 mm	D1 mm	L2 mm	L mm
80225E08	8	25	15	10	250
80225E10	10	25	17	10	250
80225E12	12	25	19.5	12	250
80225E13	13	25	21	12	250
80225E14	14	25	22	12	250
80225E15	15	25	23	12	250
80225E16	16	25	25	13	250
80225E17	17	25	26	13	250
80225E18	18	25	27	13	250
80225E19	19	30	28	13	250
80225E21	21	30	31	13	250
80225E22	22	30	32	14	250
80225E23	23	30	34	14	250
80225E24	24	30	35	15	250

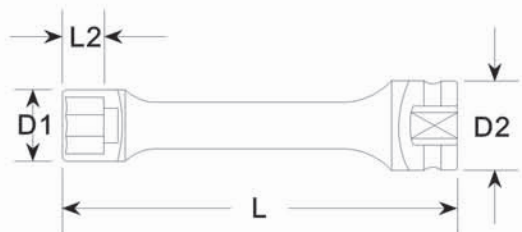

1/4"

P1-10

3/8"

P11-44

1/2"

P45-92

5/8"

P93-94

3/4"

P95-112

1"

P113-128

1-1/2"

P129-132

2-1/2"

P133-136

起子套筒

P137-145

起子头

P146-164



# NORMECO INDUSTRIAL SOCKETS

- 1/4"
- P1-10
- 3/8"
- P11-44
- 1/2"
- P45-92
- 5/8"
- P93-94
- 3/4"
- P95-112
- 1"
- P113-128
- 1-1/2"
- P129-132
- 2-1/2"
- P133-136
- 起子套筒
- P137-145
- 起子头
- P146-164

## 十二角固定磁接杆套筒 12-Point Sockets-Extented length-With Fixed Magnet

1/2" Square Drive 12-Point Sockets

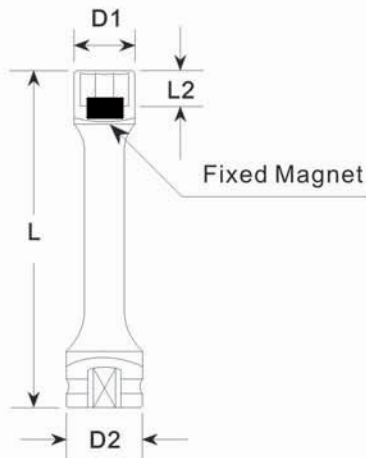

Order No.	Size mm	D2 mm	D1 mm	L2 mm	L mm
80299A08	8	25	15	4	125
80299A10	10	25	17	4	125
80299A12	12	25	19.5	5	125
80299A13	13	25	21	6	125
80299A14	14	25	22	6	125
80299A15	15	25	23	7	125
80299A16	16	25	25	7	125
80299A17	17	25	26	8	125
80299A18	18	25	27	8	125
80299A19	19	25	28	8	125
80299A21	21	25	30	9	125
80299A22	22	25	31	9	125
80299A23	23	25	34	9	125
80299A24	24	30	35	10	125

Order No.	Size mm	D2 mm	D1 mm	L2 mm	L mm
80299B08	8	25	15	4	150
80299B10	10	25	17	4	150
80299B12	12	25	19.5	5	150
80299B13	13	25	21	6	150
80299B14	14	25	22	6	150
80299B15	15	25	23	7	150
80299B16	16	25	25	7	150
80299B17	17	25	26	8	150
80299B18	18	25	27	8	150
80299B19	19	25	28	8	150
80299B21	21	25	30	9	150
80299B22	22	25	31	9	150
80299B23	23	25	34	9	150
80299B24	24	30	35	10	150

Order No.	Size mm	D2 mm	D1 mm	L2 mm	L mm
80299C08	8	25	15	4	175
80299C10	10	25	17	4	175
80299C12	12	25	19.5	5	175
80299C13	13	25	21	6	175
80299C14	14	25	22	6	175
80299C15	15	25	23	7	175
80299C16	16	25	25	7	175
80299C17	17	25	26	8	175
80299C18	18	25	27	8	175
80299C19	19	25	28	8	175
80299C21	21	25	30	9	175
80299C22	22	25	31	9	175
80299C23	23	25	34	9	175
80299C24	24	30	35	10	175

Order No.	Size mm	D2 mm	D1 mm	L2 mm	L mm
80299D08	8	25	15	4	200
80299D10	10	25	17	4	200
80299D12	12	25	19.5	5	200
80299D13	13	25	21	6	200
80299D14	14	25	22	6	200
80299D15	15	25	23	7	200
80299D16	16	25	25	7	200
80299D17	17	25	26	8	200
80299D18	18	25	27	8	200
80299D19	19	25	28	8	200
80299D21	21	25	30	9	200
80299D22	22	25	31	9	200
80299D23	23	25	34	9	200
80299D24	24	30	35	10	200

Order No.	Size mm	D2 mm	D1 mm	L2 mm	L mm
80299E08	8	25	15	4	250
80299E10	10	25	17	4	250
80299E12	12	25	19.5	5	250
80299E13	13	25	21	6	250
80299E14	14	25	22	6	250
80299E15	15	25	23	7	250
80299E16	16	25	25	7	250
80299E17	17	25	26	8	250
80299E18	18	25	27	8	250
80299E19	19	25	28	8	250
80299E21	21	25	30	9	250
80299E22	22	25	31	9	250
80299E23	23	25	34	9	250
80299E24	24	30	35	10	250





## 外星型标准套筒 1/2" Square Drive With External Torx

1/2" Square Drive
 External Torx

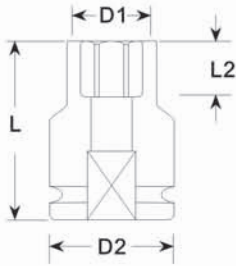

Order No.		D2 mm	D1 mm	L2 mm	L mm
80175510	E10	25	15	7.5	38
80175511	E11	25	15.5	8	38
80175512	E12	25	16	8.5	38
80175514	E14	25	18.5	10	38
80175516	E16	25	20	11	38
80175518	E18	25	22	12	38
80175520	E20	25	25	13.5	38
80175522	E22	25	26.5	18	45
80175524	E24	30	28.5	18	45



## 外星型薄壁套筒 1/2" Square Drive With External Torx-Thin Wall

1/2" Square Drive
 External Torx

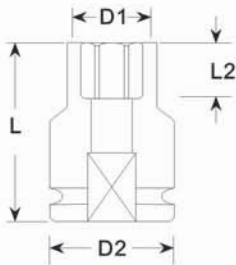

Order No.		D2 mm	D1 mm	L2 mm	L mm
80175710	E10	25	13	7.5	38
80175711	E11	25	14	8	38
80175712	E12	25	15	8.5	38
80175714	E14	25	17	10	38
80175716	E16	25	18.5	11	38
80175718	E18	25	20.5	12	38
80175720	E20	25	22.5	13.5	38
80175722	E22	25	24.5	18	45
80175724	E24	26.5	26.5	18	45



仅适用于狭窄工位常规扭矩环境。  
 Access in narrow space application at low torque range.

- 1/4"
- P1-10
- 3/8"
- P11-44
- 1/2"
- P45-92
- 5/8"
- P93-94
- 3/4"
- P95-112
- 1"
- P113-128
- 1-1/2"
- P129-132
- 2-1/2"
- P133-136
- 起子套筒
- P137-145
- 起子头
- P146-164



# NORMECO INDUSTRIAL SOCKETS

- 1/4"
- P1-10
- 3/8"
- P11-44
- 1/2"
- P45-92
- 5/8"
- P93-94
- 3/4"
- P95-112
- 1"
- P113-128
- 1-1/2"
- P129-132
- 2-1/2"
- P133-136
- 起子套筒
- P137-145
- 起子头
- P146-164

## ▶ 外星型固定磁标准套筒 1/2" Square Drive With External Torx-With Fixed Magnet

1/2" Square Drive External Torx

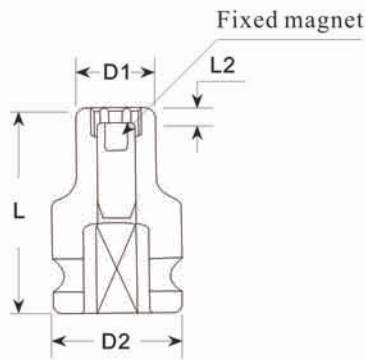

Order No.	Bit	D2 mm	D1 mm	L2 mm	L mm
80177608	E8	25	11.5	5	38
80177610	E10	25	14.5	5.5	38
80177611	E11	25	15	5.5	38
80177612	E12	25	16	6	38
80177614	E14	25	18.5	8	38
80177616	E16	25	20	9	38
80177618	E18	25	22	9	38
80177620	E20	25	25	10	38
80177622	E22	25	26.5	11	45
80177624	E24	30	29	13	45



## ▶ 外星型加长套筒 1/2" Square Drive With External Torx-Deep

1/2" Square Drive External Torx

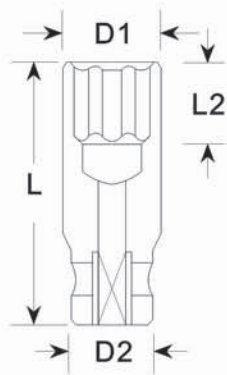

Order No.	Bit	D2 mm	D1 mm	L2 mm	L mm
80175810	E10	25	14.5	7.5	78
80175811	E11	25	15	8	78
80175812	E12	25	16	8.5	78
80175814	E14	25	18.5	10	78
80175816	E16	25	20	11	78
80175818	E18	25	22	12	78
80175820	E20	25	25	13.5	78
80175822	E22	25	26.5	21	78
80175824	E24	30	28.5	21	78



# NORMECO INDUSTRIAL SOCKETS



## 四方标准套筒 4-Point Female Sockets

1/2" Square Drive 4-Point Female

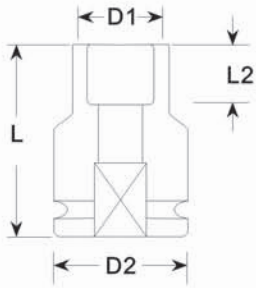

Order No.	Size mm	D2 mm	D1 mm	L2 mm	L mm
80178508	8	25	19	9	40
80178509	9	25	20	9	40
80178510	10	25	21.5	10	40
80178512	12	25	24	12	40
80178514	14	30	27.5	14	40
80178517	17	30	32	20	45
80178518	18	30	34	20	45
80178519	19	30	36	20	45



## 双头螺栓套筒 Stud Bolt Impact Sockets

1/2" Square Drive Stud Bolt Impact Sockets

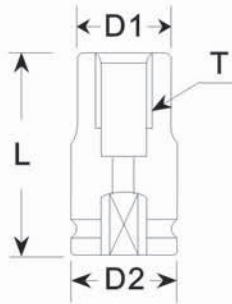

Order No.	T	D2 mm	D1 mm	L mm
80182515	M6×P1.0	25	13	55
80182517	M7×P1.0	25	14	55
80182520	M8×P1.0	25	15	55
80182521	M8×P1.25	25	15	55
80182523	M10×P1.0	25	18	55
80182525	M10×P1.25	25	18	55
80182526	M10×P1.5	25	18	55
80182530	M12×P1.25	25	20	55
80182532	M12×P1.5	25	20	55
80182536	M12×P1.75	25	20	55
80182538	M14×P1.5	25	22	70
80182542	M14×P2.0	25	22	70
80182546	M16×P1.5	30	27	75
80182548	M16×P2.0	30	27	75
80182552	M18×P2.0	30	29	75
80182556	M18×P2.5	30	29	75
80182558	M20×P1.5	30	30	75
80182560	M20×P2.0	30	30	75
80182562	M20×P2.5	30	30	75
80182566	M24×P3.0	30	34	75
80182570	1/4"-20UNC	25	13	55
80182573	5/16"-18UNC	25	15	55
80182576	3/8"-16UNC	25	18	55
80182579	7/16"-14UNC	25	19	55
80182583	1/2"-13UNC	25	20	55
80182586	9/16"-12UNC	25	22	55
80182589	5/8"-11UNC	30	27	75
80182593	3/4"-10UNC	30	29	75



# NORMECO INDUSTRIAL SOCKETS

1/4"	P1-10
3/8"	P11-44
1/2"	P45-92
5/8"	P93-94
3/4"	P95-112
1"	P113-128
1-1/2"	P129-132
2-1/2"	P133-136
起子套筒	P137-145
起子头	P146-164

## 六角大圆弧标准套筒 6-Point Surface Drive Sockets

1/2" Square Drive
 Surface Drive

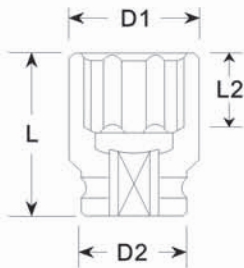

Order No.	Size inch	D2 mm	D1 mm	L2 mm	L mm
80465455	5/16 "	25	15	9	38
80465456	3/8 "	25	16	12	38
80465457	7/16 "	25	18	12	38
80465458	1/2 "	25	20	12	38
80465459	9/16 "	30	22	12	38
80465460	5/8 "	30	25	12	38
80465461	11/16 "	30	26	13	38
80465462	3/4 "	30	28	13	38
80465463	13/16 "	30	30	13	38
80465464	7/8 "	30	32	13	38
80465465	15/16 "	30	34	13	45
80465466	1 "	30	36	14	50
80465467	1-1/16 "	30	38	16	50
80465468	1-1/8 "	30	40	16	50
80465469	1-3/16 "	30	42	16	50
80465470	1-1/4 "	30	44	18	50

Order No.	Size mm	D2 mm	D1 mm	L2 mm	L mm
80465408	8	25	14	8	38
80465409	9	25	16	9	38
80465410	10	25	16	10	38
80465411	11	25	18.7	10	38
80465412	12	25	19	12	38
80465413	13	25	20	12	38
80465414	14	25	22	12	38
80465415	15	25	23	12	38
80465416	16	25	25	12	38
80465417	17	26	26	13	38
80465418	18	27	27	13	38
80465419	19	30	28	13	38
80465420	20	30	30	13	38
80465421	21	30	31	13	38
80465422	22	30	32	13	38
80465423	23	30	32	13	38
80465424	24	30	35	20	45
80465425	25	30	36	20	45
80465426	26	30	38	20	50
80465427	27	30	39	20	50
80465428	28	30	40	20	50
80465429	29	30	40	20	50
80465430	30	30	41	20	50
80465431	31	30	43	22	50
80465432	32	30	44	22	50

大圆弧的设计使六角螺丝更快捷地对位并导入套筒，从而实现高速装配。  
 Surface drive design makes the hexagonal screw more quickly aligned and introduced into the impact socket, so as to achieve faster assembling.



## 六角大圆弧加长套筒 6-Point Surface Drive Sockets-Deep Length

 1/2" Square Drive
  Surface Drive

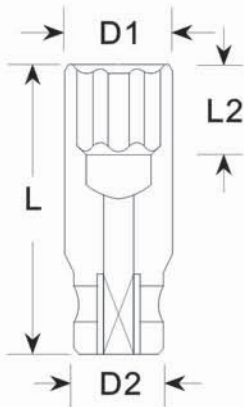

Order No.	Size inch	D2 mm	D1 mm	L2 mm	L mm
80465555	5/16 "	25	15	12	83
80465556	3/8 "	25	16	14	83
80465557	7/16 "	25	18	14	83
80465558	1/2 "	25	20	14	83
80465559	9/16 "	30	22	17	83
80465560	5/8 "	30	25	17	83
80465561	11/16 "	30	26	17	83
80465562	3/4 "	30	28	19	83
80465563	13/16 "	30	30	24	83
80465564	7/8 "	30	32	24	90
80465565	15/16 "	30	34	24	90
80465566	1 "	30	36	24	90
80465567	1-1/16 "	30	38	24	90
80465568	1-1/8 "	30	40	24	90
80465569	1-3/16 "	30	42	24	90
80465570	1-1/4 "	30	44	24	90

Order No.	Size mm	D2 mm	D1 mm	L2 mm	L mm
80465508	8	25	14	12	83
80465509	9	25	16	14	83
80465510	10	25	16	14	83
80465511	11	25	18.7	14	83
80465512	12	25	19	14	83
80465513	13	25	20	14	83
80465514	14	25	22	17	83
80465515	15	25	23	17	83
80465516	16	25	25	17	83
80465517	17	26	26	17	83
80465518	18	27	27	17	83
80465519	19	30	28	19	83
80465520	20	30	30	19	83
80465521	21	30	31	24	83
80465522	22	30	32	24	90
80465523	23	30	32	24	90
80465524	24	30	35	24	90
80465525	25	30	36	24	90
80465526	26	30	38	24	90
80465527	27	30	38	24	90
80465528	28	30	40	24	90
80465529	29	30	40	24	90
80465530	30	30	41	24	90
80465531	31	30	43	24	90
80465532	32	30	44	24	90

大圆弧的设计使六角螺丝更快捷地对位并导入套筒, 从而实现高速装配。  
 Surface drive design makes the hexagonal screw more quickly aligned and introduced into the impact socket, so as to achieve faster assembling.



# NORMECO INDUSTRIAL SOCKETS

- 1/4" P1-10
- 3/8" P11-44
- 1/2" P45-92
- 5/8" P93-94
- 3/4" P95-112
- 1" P113-128
- 1-1/2" P129-132
- 2-1/2" P133-136
- 起子套筒 P137-145
- 起子头 P146-164

## 八角标准套筒 Double Square Sockets

1/2" Square Drive
 8-Point Sockets

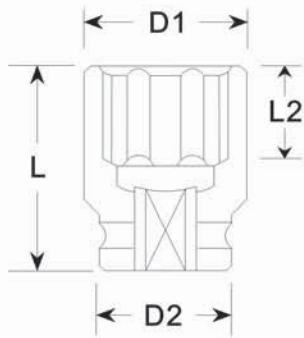

Order No.	Size inch	D2 mm	D1 mm	L2 mm	L mm
80466312	3/8 "	24	19	6	38
80466314	7/16 "	24	21	8	38
80466316	1/2 "	24	24	9	38
80466318	9/16 "	26	26	11	38
80466320	5/8 "	28	28	11	38
80466322	11/16 "	30	30	11	38
80466324	3/4 "	34	34	13	40
80466326	13/16 "	36	36	15	40
80466328	7/8 "	38	38	15	40
80466330	15/16 "	38	42	18	45
80466332	1 "	38	44	18	45
80466334	1-1/16 "	38	46.5	19	50
80466336	1-1/8 "	38	49	19	50
80466338	1-3/16 "	38	51	21	50
80466340	1-1/4 "	38	54	22	50

Order No.	Size mm	D2 mm	D1 mm	L2 mm	L mm
80466510	10	24	20	7	38
80466511	11	24	21	8	38
80466512	12	24	24	9	38
80466513	13	25	25	9	38
80466514	14	26	26	11	38
80466515	15	28	28	11	38
80466516	16	28	28	11	38
80466517	17	30	30	11	38
80466518	18	32	32	13	40
80466519	19	34	34	13	40
80466520	20	35	35	13	40
80466521	21	36	36	15	40
80466522	22	38	38	15	40
80466523	23	38	40	15	40
80466524	24	38	42	18	45
80466525	25	38	44	18	45
80466526	26	38	45	18	50
80466527	27	38	46.5	19	50
80466528	28	38	49	19	50
80466529	29	38	50	19	50
80466530	30	38	51	21	50
80466531	31	38	52	21	50
80466532	32	38	54	22	50

# NORMECO INDUSTRIAL SOCKETS



## 八角加长套筒 Double Square Sockets-Deep Length

 1/2 " Square Drive
  8-Point Sockets

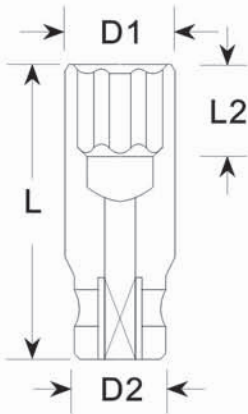

Order No.	Size inch	D2 mm	D1 mm	L2 mm	L mm
80466712	3/8 "	24	19	6	83
80466714	7/16 "	24	21	8	83
80466716	1/2 "	24	24	9	83
80466718	9/16 "	26	26	11	83
80466720	5/8 "	28	28	11	83
80466722	11/16 "	30	30	11	83
80466724	3/4 "	34	34	13	83
80466726	13/16 "	36	36	15	83
80466728	7/8 "	38	38	15	90
80466730	15/16 "	38	42	18	90
80466732	1 "	38	44	18	90
80466734	1-1/16 "	38	46.5	19	90
80466736	1-1/8 "	38	49	19	90
80466738	1-3/16 "	38	51	21	90
80466740	1-1/4 "	38	54	22	90

Order No.	Size mm	D2 mm	D1 mm	L2 mm	L mm
80466910	10	24	20	7	83
80466911	11	24	21	8	83
80466912	12	24	24	9	83
80466913	13	25	25	9	83
80466914	14	26	26	11	83
80466915	15	28	28	11	83
80466916	16	28	28	11	83
80466917	17	30	30	11	83
80466918	18	32	32	13	83
80466919	19	34	34	13	83
80466920	20	35	35	13	83
80466921	21	36	36	15	83
80466922	22	38	38	15	90
80466923	23	38	40	15	90
80466924	24	38	42	18	90
80466925	25	38	44	18	90
80466926	26	38	45	18	90
80466927	27	38	46.5	19	90
80466928	28	38	49	19	90
80466929	29	38	50	19	90
80466930	30	38	51	21	90
80466931	31	38	52	21	90
80466932	32	38	54	22	90

1/4 "

P1-10

3/8 "

P11-44

1/2 "

P45-92

5/8 "

P93-94

3/4 "

P95-112

1 "

P113-128

1-1/2 "

P129-132

2-1/2 "

P133-136

起子套筒

P137-145

起子头

P146-164



# NORMECO INDUSTRIAL SOCKETS

1/4"
P1-10
3/8"
P11-44
1/2"
P45-92
5/8"
P93-94
3/4"
P95-112
1"
P113-128
1-1/2"
P129-132
2-1/2"
P133-136
起子套筒
P137-145
起子头
P146-164

## 丝攻套筒 Tap Holding Sockets

1/2" Square Drive Tap

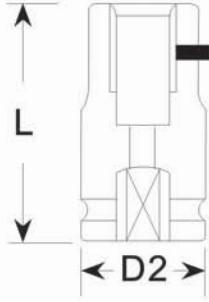

Order No.	Sq mm	T Size	D2 mm	L mm
80180345	4.5	M5 M6	25	50
80180350	5	M7 M8	25	50
80180355	5.5	M10	25	50
80180365	6.5	M12	25	50
80180380	8.0	M14	25	50
80180400	10.0	M16	25	50
80180410	11.0	M18	25	50



## 旋护套筒 Standard Sockets With Rotating Cover

1/2" Square Drive

Rotating Cover  
Flat Rotating Cover

Order No.	Size mm	D2 mm	D1 mm	L2 mm	L mm
No. + RC	-	-	-	-	-
No. + FRC	-	-	-	-	-

6-Point Sockets  
六角套筒

12-Point Sockets  
十二角套筒

6-Point Surface Drive Sockets  
大圆弧套筒

External Torx Sockets  
外星型套筒

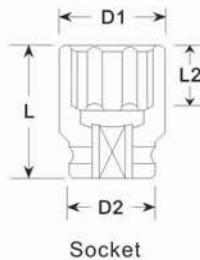

Socket



Rotating Cover  
端面防护型

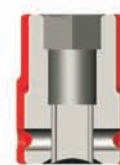

Flat Rotating Cover  
端面齐平型



诺麦柯旋护套筒实现套筒在护套内的自由旋转，从而减少或消除紧固作业中人与旋转部件的接触，除了提高操作人员安全性，同时也有助于最大限度地减少系统损坏和紧固过程中造成的碰撞。 Normeco rotating cover is designed to enable the impact socket spinning freely inside the cover, Which significantly reducing or even eliminating the access between operators and rotating parts during tightening. It improves safety, and helps to minimize the risk of system damage and marring work pieces during fastening operation.

# NORMECO INDUSTRIAL SOCKETS



## 内六角套筒 Male Hex Drive Sockets

1/2" Square Drive Male Hex Drive Sockets

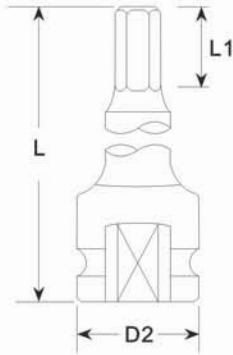

Order No.	Size inch	D2 mm	L1 mm	L mm
80536006	3/16"	25	11	75
80536007	7/32"	25	15	75
80536008	1/4"	25	15	75
80536009	9/32"	25	20	75
80536010	5/16"	25	25	75
80536012	3/8"	25	25	75
80536014	7/16"	25	25	75
80536016	1/2"	25	25	75
80536018	9/16"	30	25	75
80536020	5/8"	30	25	75
80536022	11/16"	30	25	75
80536024	3/4"	30	25	75

Order No.	Size inch	D2 mm	L1 mm	L mm
80537006	3/16"	25	11	100
80537007	7/32"	25	15	100
80537008	1/4"	25	15	100
80537009	9/32"	25	20	100
80537010	5/16"	25	25	100
80537012	3/8"	25	25	100
80537014	7/16"	25	25	100
80537016	1/2"	25	25	100
80537018	9/16"	30	25	100
80537020	5/8"	30	25	100
80537022	11/16"	30	25	100
80537024	3/4"	30	25	100

Order No.	Size inch	D2 mm	L1 mm	L mm
80554006	3/16"	25	11	125
80554007	7/32"	25	15	125
80554008	1/4"	25	15	125
80554009	9/32"	25	20	125
80554010	5/16"	25	25	125
80554012	3/8"	25	25	125
80554014	7/16"	25	25	125
80554016	1/2"	25	25	125
80554018	9/16"	30	25	125
80554020	5/8"	30	25	125
80554022	11/16"	30	25	125
80554024	3/4"	30	25	125

Order No.	Size inch	D2 mm	L1 mm	L mm
80532006	3/16"	25	11	55
80532007	7/32"	25	15	55
80532008	1/4"	25	15	55
80532009	9/32"	25	16	55
80532010	5/16"	25	16	55
80532012	3/8"	25	16	55
80532014	7/16"	25	16	55
80532016	1/2"	25	16	55
80532018	9/16"	30	20	55
80532020	5/8"	30	20	55
80532022	11/16"	30	20	55
80532024	3/4"	30	20	55

Order No.	Size inch	D2 mm	L1 mm	L mm
80558006	3/16"	25	11	150
80558007	7/32"	25	15	150
80558008	1/4"	25	15	150
80558009	9/32"	25	20	150
80558010	5/16"	25	25	150
80558012	3/8"	25	25	150
80558014	7/16"	25	25	150
80558016	1/2"	25	25	150
80558018	9/16"	30	25	150
80558020	5/8"	30	25	150
80558022	11/16"	30	25	150
80558024	3/4"	30	25	150

1/4"
P1-10
3/8"
P11-44
1/2"
P45-92
5/8"
P93-94
3/4"
P95-112
1"
P113-128
1-1/2"
P129-132
2-1/2"
P133-136
起子套筒
P137-145
起子头
P146-164



# NORMECO INDUSTRIAL SOCKETS

- 1/4" P1-10
- 3/8" P11-44
- 1/2" P45-92
- 5/8" P93-94
- 3/4" P95-112
- 1" P113-128
- 1-1/2" P129-132
- 2-1/2" P133-136
- 起子套筒 P137-145
- 起子头 P146-164

## 内六角套筒 Male Hex Drive Sockets

1/2" Square Drive Hex

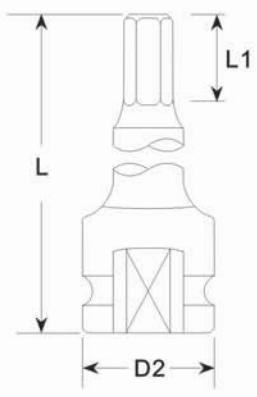

Order No.	Size mm	D2 mm	L1 mm	L mm
80530004	4	25	11	55
80530005	5	25	15	55
80530006	6	25	15	55
80530007	7	25	15	55
80530008	8	25	15	55
80530009	9	25	15	55
80530010	10	25	15	55
80530011	11	25	15	55
80530012	12	25	15	55
80530013	13	25	15	55
80530014	14	30	20	55
80530015	15	30	20	55
80530016	16	30	20	55
80530017	17	30	20	55
80530018	18	30	20	55
80530019	19	30	20	55
80530020	20	30	20	55
80530021	21	30	20	55
80530022	22	30	20	55

Order No.	Size mm	D2 mm	L1 mm	L mm
80534004	4	25	11	75
80534005	5	25	15	75
80534006	6	25	15	75
80534007	7	25	20	75
80534008	8	25	25	75
80534009	9	25	25	75
80534010	10	25	25	75
80534011	11	25	25	75
80534012	12	25	25	75
80534013	13	25	25	75
80534014	14	30	25	75
80534015	15	30	25	75
80534016	16	30	25	75
80534017	17	30	25	75
80534018	18	30	25	75
80534019	19	30	25	75
80534020	20	30	25	75
80534021	21	30	25	75
80534022	22	30	25	75
80534024	24	34	25	75
80534027	27	34	25	75
80534030	30	34	25	75

Order No.	Size mm	D2 mm	L1 mm	L mm
80538004	4	25	11	100
80538005	5	25	15	100
80538006	6	25	15	100
80538007	7	25	20	100
80538008	8	25	25	100
80538009	9	25	25	100
80538010	10	25	25	100
80538011	11	25	25	100
80538012	12	25	25	100
80538013	13	25	25	100
80538014	14	30	25	100
80538015	15	30	25	100
80538016	16	30	25	100
80538017	17	30	25	100
80538018	18	30	25	100
80538019	19	30	25	100
80538020	20	30	25	100
80538021	21	30	25	100
80538022	22	30	25	100

# NORMECO INDUSTRIAL SOCKETS



## 内六角套筒 Male Hex Drive Sockets

 1/2" Square Drive
  Hex

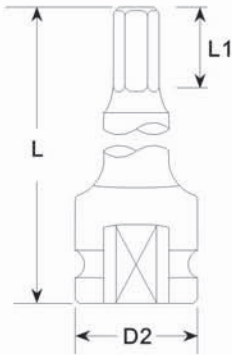

Order No.	● Size mm	D2 mm	L1 mm	L mm
80552004	4	25	11	125
80552005	5	25	15	125
80552006	6	25	15	125
80552007	7	25	20	125
80552008	8	25	25	125
80552009	9	25	25	125
80552010	10	25	25	125
80552011	11	25	25	125
80552012	12	25	25	125
80552013	13	25	25	125
80552014	14	30	25	125
80552015	15	30	25	125
80552016	16	30	25	125
80552017	17	30	25	125
80552018	18	30	25	125
80552019	19	30	25	125
80552020	20	30	25	125
80552021	21	30	25	125
80552022	22	30	25	125

Order No.	● Size mm	D2 mm	L1 mm	L mm
80556004	4	25	11	150
80556005	5	25	15	150
80556006	6	25	15	150
80556007	7	25	20	150
80556008	8	25	25	150
80556009	9	25	25	150
80556010	10	25	25	150
80556011	11	25	25	150
80556012	12	25	25	150
80556013	13	25	25	150
80556014	14	30	25	150
80556015	15	30	25	150
80556016	16	30	25	150
80556017	17	30	25	150
80556018	18	30	25	150
80556019	19	30	25	150
80556020	20	30	25	150
80556021	21	30	25	150
80556022	22	30	25	150

 1/4"
P1-10
 3/8"
P11-44
 1/2"
P45-92
 5/8"
P93-94
 3/4"
P95-112
 1"
P113-128
 1-1/2"
P129-132
 2-1/2"
P133-136
 起子套筒:
P137-145
起子头
P146-164



# NORMECO INDUSTRIAL SOCKETS

- 1/4" P1-10
- 3/8" P11-44
- 1/2" P45-92
- 5/8" P93-94
- 3/4" P95-112
- 1" P113-128
- 1-1/2" P129-132
- 2-1/2" P133-136
- 起子套筒 P137-145
- 起子头 P146-164

## 球头内六角套筒 Ball Male Hex Drive Sockets

1/2" Square Drive Hex

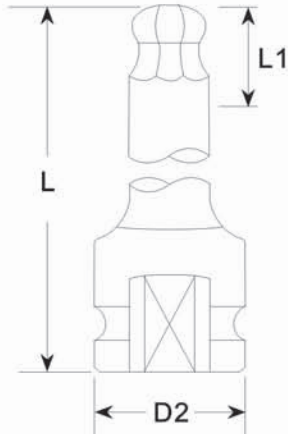

Order No.	● Size mm	D2 mm	L1 mm	L mm
80535004	4	25	11	75
80535005	5	25	15	75
80535006	6	25	15	75
80535007	7	25	20	75
80535008	8	25	25	75
80535009	9	25	25	75
80535010	10	25	25	75
80535011	11	25	25	75
80535012	12	25	25	75
80535013	13	25	25	75
80535014	14	30	25	75
80535015	15	30	25	75
80535016	16	30	25	75
80535017	17	30	25	75
80535018	18	30	25	75
80535019	19	30	25	75
80535020	20	30	25	75
80535021	21	30	25	75
80535022	22	30	25	75
80535024	24	34	25	75
80535027	27	34	25	75
80535030	30	34	25	75



Application  
 适用于存在局部工位干涉的场所。  
 Suitable for places with local workstation interference.



## ▶ 内十二角套筒 Triple square Male Sockets

 1/2" Square Drive
  Triple square

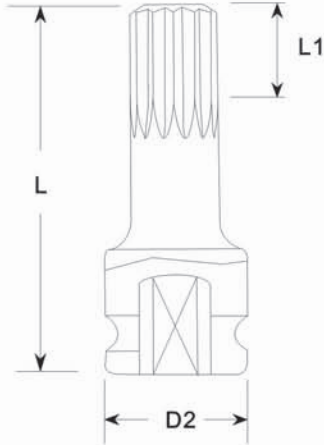

Order No.	□ Square	⚙ Size	D2 mm	L1 mm	L mm
80582805	1/2"	M5	25	7	55
80582806	1/2"	M6	25	7	55
80582808	1/2"	M8	25	8	55
80582810	1/2"	M10	25	8	55
80582812	1/2"	M12	25	10	55
80582814	1/2"	M14	25	11	55
80582816	1/2"	M16	30	13	55

Order No.	□ Square	⚙ Size	D2 mm	L1 mm	L mm
80582835	1/2"	M5	25	7	100
80582836	1/2"	M6	25	7	100
80582838	1/2"	M8	25	8	100
80582840	1/2"	M10	25	8	100
80582842	1/2"	M12	25	10	100
80582844	1/2"	M14	25	11	100
80582846	1/2"	M16	30	13	100

Order No.	□ Square	⚙ Size	D2 mm	L1 mm	L mm
80582875	1/2"	M5	25	7	150
80582876	1/2"	M6	25	7	150
80582878	1/2"	M8	25	8	150
80582880	1/2"	M10	25	8	150
80582882	1/2"	M12	25	10	150
80582884	1/2"	M14	25	11	150
80582886	1/2"	M16	30	13	150

1/4"
P11-10
3/8"
P11-44
1/2"
P45-92
5/8"
P93-94
3/4"
P95-112
1"
P113-128
1-1/2"
P129-132
2-1/2"
P133-136
起子套筒
P137-145
起子头
P146-164



# NORMECO INDUSTRIAL SOCKETS

- 1/4" P1-10
- 3/8" P11-44
- 1/2" P45-92
- 5/8" P93-94
- 3/4" P95-112
- 1" P113-128
- 1-1/2" P129-132
- 2-1/2" P133-136
- P137-145
- P146-164

## 内星型套筒 Internal Torx Sockets

1/2" Square Drive Internal Torx

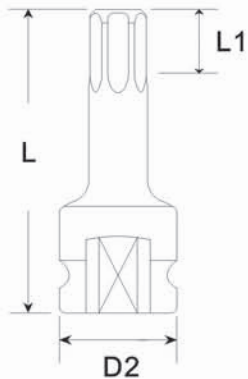

Order No.	★	A mm	D2 mm	L1 mm	L mm
80172420	T20	3.84	25	2.8	55
80172425	T25	4.4	25	3	55
80172427	T27	4.96	25	3	55
80172430	T30	5.5	25	3.5	55
80172440	T40	6.6	25	4	55
80172445	T45	7.77	25	4.5	55
80172447	T47	7.96	25	4.5	55
80172450	T50	8.8	25	5	55
80172455	T55	11.2	25	5.5	55
80172460	T60	13.25	25	6	55

Order No.	★	A mm	D2 mm	L1 mm	L mm
80172520	T20	3.84	25	2.8	75
80172525	T25	4.4	25	3	75
80172527	T27	4.96	25	3	75
80172530	T30	5.5	25	3.5	75
80172540	T40	6.6	25	4	75
80172545	T45	7.77	25	4.5	75
80172547	T47	7.96	25	4.5	75
80172550	T50	8.8	25	5	75
80172555	T55	11.2	25	5.5	75
80172560	T60	13.25	25	6	75

Order No.	★	A mm	D2 mm	L1 mm	L mm
80172720	T20	3.84	25	2.8	100
80172725	T25	4.4	25	3	100
80172727	T27	4.96	25	3	100
80172730	T30	5.5	25	3.5	100
80172740	T40	6.6	25	4	100
80172745	T45	7.77	25	4.5	100
80172747	T47	7.96	25	4.5	100
80172750	T50	8.8	25	5	100
80172755	T55	11.2	25	5.5	100
80172760	T60	13.25	25	6	100

Order No.	★	A mm	D2 mm	L1 mm	L mm
80172920	T20	3.84	25	2.8	150
80172925	T25	4.4	25	3	150
80172927	T27	4.96	25	3	150
80172930	T30	5.5	25	3.5	150
80172940	T40	6.6	25	4	150
80172945	T45	7.77	25	4.5	150
80172947	T47	7.96	25	4.5	150
80172950	T50	8.8	25	5	150
80172955	T55	11.2	25	5.5	150
80172960	T60	13.25	25	6	150



▶ 旋护内方套筒 Rotating Cover Sockets

Order No.	D2 mm	L mm
No. +RC	-	-

 1/2" Square Drive

 Hex Sockets  
内六角套筒

 Internal Torx Sockets  
内星型套筒

 Triple square Sockets  
内十二角套筒

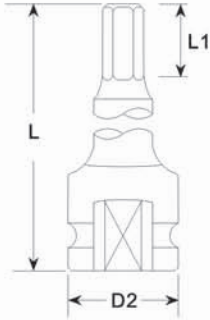

 1/4"

P1-10

 3/8"

P11-44

 1/2"

P45-92

 5/8"

P93-94

 3/4"

P95-112

 1"

P113-128

 1-1/2"

P129-132

 2-1/2"

P133-136

 起子套筒

P137-145

 起子头

P146-164

诺麦柯旋护套筒实现套筒在护套内的自由旋转，从而减少或消除紧固作业中人与旋转部件的接触，除了提高操作人员安全性，同时也有助于最大限度地减少系统损坏和紧固过程中造成的碰撞。  
Normeco rotating cover is designed to enable the impact socket spinning freely inside the cover, Which significantly reducing or even eliminating the access between operators and rotating parts during tightening. It improves safety, and helps to minimize the risk of system damage and marring work pieces during fastening operation.



# NORMECO INDUSTRIAL SOCKETS

1/4"
P1-10
3/8"
P11-44
1/2"
P45-92
5/8"
P93-94
3/4"
P95-112
1"
P113-128
1-1/2"
P129-132
2-1/2"
P133-136
起子套筒
P137-145
起子头
P146-164

## 延长杆 Extension Bars

1/2" Square Drive Extension Bars

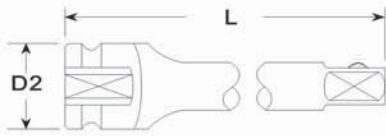

Order No.	1/2" Inch	1/2" Inch	D2 mm	L mm	Male End Type
80625050	1/2"	1/2"	25	50	Steel Ball
80625075	1/2"	1/2"	25	75	Steel Ball
80625100	1/2"	1/2"	25	100	Steel Ball
80625125	1/2"	1/2"	25	125	Steel Ball
80625150	1/2"	1/2"	25	150	Steel Ball
80625175	1/2"	1/2"	25	175	Steel Ball
80625200	1/2"	1/2"	25	200	Steel Ball
80625250	1/2"	1/2"	25	250	Steel Ball
80625300	1/2"	1/2"	25	300	Steel Ball

Order No.	1/2" Inch	1/2" Inch	D2 mm	L mm	Male End Type
80627050	1/2"	1/2"	25	50	Lock Pin
80627075	1/2"	1/2"	25	75	Lock Pin
80627100	1/2"	1/2"	25	100	Lock Pin
80627125	1/2"	1/2"	25	125	Lock Pin
80627150	1/2"	1/2"	25	150	Lock Pin
80627175	1/2"	1/2"	25	175	Lock Pin
80627200	1/2"	1/2"	25	200	Lock Pin
80627250	1/2"	1/2"	25	250	Lock Pin
80627300	1/2"	1/2"	25	300	Lock Pin

Order No.	1/2" Inch	1/2" Inch	D2 mm	L mm	Male End Type
80629050	1/2"	1/2"	25	50	Pin Hole
80629075	1/2"	1/2"	25	75	Pin Hole
80629100	1/2"	1/2"	25	100	Pin Hole
80629125	1/2"	1/2"	25	125	Pin Hole
80629150	1/2"	1/2"	25	150	Pin Hole
80629175	1/2"	1/2"	25	175	Pin Hole
80629200	1/2"	1/2"	25	200	Pin Hole
80629250	1/2"	1/2"	25	250	Pin Hole
80629300	1/2"	1/2"	25	300	Pin Hole

## 抗震型延长杆 Anti-vibration Extension Bars

1/2" Square Drive Extension Bars

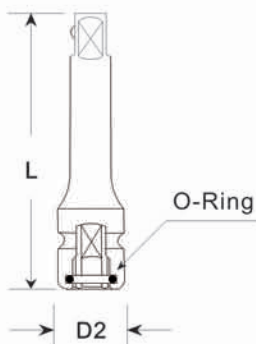

Order No.	1/2" Inch	1/2" Inch	D2 mm	L mm	Male End Type
80644050	1/2"	1/2"	25	50	Steel Ball
80644100	1/2"	1/2"	25	100	Steel Ball
80644150	1/2"	1/2"	25	150	Steel Ball
80644200	1/2"	1/2"	25	200	Steel Ball
80644250	1/2"	1/2"	25	250	Steel Ball
80644300	1/2"	1/2"	25	300	Steel Ball

Order No.	1/2" Inch	1/2" Inch	D2 mm	L mm	Male End Type
80645050	1/2"	1/2"	25	50	Lock Pin
80645100	1/2"	1/2"	25	100	Lock Pin
80645150	1/2"	1/2"	25	150	Lock Pin
80645200	1/2"	1/2"	25	200	Lock Pin
80645250	1/2"	1/2"	25	250	Lock Pin
80645300	1/2"	1/2"	25	300	Lock Pin

Order No.	1/2" Inch	1/2" Inch	D2 mm	L mm	Male End Type
80646050	1/2"	1/2"	25	50	Pin Hole
80646100	1/2"	1/2"	25	100	Pin Hole
80646150	1/2"	1/2"	25	150	Pin Hole
80646200	1/2"	1/2"	25	200	Pin Hole
80646250	1/2"	1/2"	25	250	Pin Hole
80646300	1/2"	1/2"	25	300	Pin Hole



## ▶ 旋护延长杆 Rotating Cover Extension Bars

1/2" Square Drive
  Extension Bars



诺麦柯旋护套筒实现套筒在护套内的自由旋转，从而减少或消除紧固作业中人与旋转部件的接触，除了提高操作人员安全性，同时也有助于最大限度地减少系统损坏和紧固过程中造成的碰撞。

Normeco rotating cover is designed to enable the impact socket spinning freely inside the cover, which significantly reducing or even eliminating the access between operators and rotating parts during tightening. It improves safety, and helps to minimize the risk of system damage and marring work pieces during fastening operation.

Order No.	D2 mm	L mm	Male End Type
No. +RC	-	-	Steel Ball
No. +RC	-	-	Lock Pin



## ▶ 快换式延长杆 Quick-Change Extension Bars

1/2" Square Drive
  Square

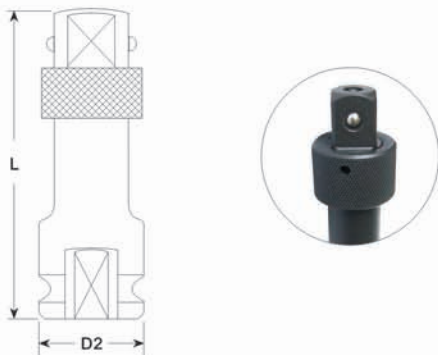

Order No.	<span style="display: inline-block; width: 15px; height: 15px; border: 1px solid black;"></span> Inch	<span style="display: inline-block; width: 15px; height: 15px; background-color: black;"></span> Inch	D2 mm	L mm	Male End Type
80629C10	1/2"	1/2"	25	60	Steel Ball
80629C15	1/2"	1/2"	25	100	Steel Ball
80629C20	1/2"	1/2"	25	125	Steel Ball
80629C25	1/2"	1/2"	25	150	Steel Ball
80629C30	1/2"	1/2"	25	200	Steel Ball
80629C35	1/2"	1/2"	25	250	Steel Ball
80629C40	1/2"	1/2"	25	300	Steel Ball



<span style="display: inline-block; width: 15px; height: 15px; border: 1px solid black;"></span>	1/4"
P1-10	
<span style="display: inline-block; width: 15px; height: 15px; border: 1px solid black;"></span>	3/8"
P11-44	
<span style="display: inline-block; width: 15px; height: 15px; border: 1px solid black;"></span>	1/2"
P45-92	
<span style="display: inline-block; width: 15px; height: 15px; border: 1px solid black;"></span>	5/8"
P93-94	
<span style="display: inline-block; width: 15px; height: 15px; border: 1px solid black;"></span>	3/4"
P95-112	
<span style="display: inline-block; width: 15px; height: 15px; border: 1px solid black;"></span>	1"
P113-128	
<span style="display: inline-block; width: 15px; height: 15px; border: 1px solid black;"></span>	1-1/2"
P129-132	
<span style="display: inline-block; width: 15px; height: 15px; border: 1px solid black;"></span>	2-1/2"
P133-136	
<span style="display: inline-block; width: 15px; height: 15px; background-color: black;"></span>	起子套筒
P137-145	
<span style="display: inline-block; width: 15px; height: 15px; background-color: black;"></span>	起子头
P146-164	



# NORMECO INDUSTRIAL SOCKETS

1/4"
P1-10
3/8"
P11-44
1/2"
P45-92
5/8"
P93-94
3/4"
P95-112
1"
P113-128
1-1/2"
P129-132
2-1/2"
P133-136
起子套筒
P137-145
起子头
P146-164

## 快换式转换杆 Quick-Change Adapter

1/2" Square Drive ■ Square

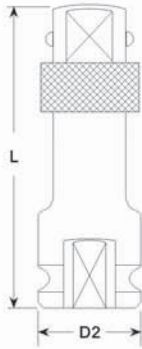

Order No.	□ Inch	■ Inch	D2 mm	L mm	Male End Type
80666505	1/2"	3/8"	25	54	Steel Ball
80666510	1/2"	3/8"	25	100	Steel Ball
80666512	1/2"	3/8"	25	125	Steel Ball
80666515	1/2"	3/8"	25	150	Steel Ball
80666520	1/2"	3/8"	25	200	Steel Ball
80666525	1/2"	3/8"	25	250	Steel Ball
80666530	1/2"	3/8"	25	300	Steel Ball

## 万向接头 1/2" Universal Joints

1/2" Square Drive ■ Universal Joints

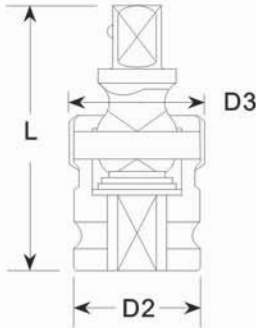

Order No.	□ Inch	■ Inch	D2 mm	D3 mm	L mm	Male End Type
80668520	1/2"	1/2"	27.5	31	60	Steel Ball
80668522	1/2"	1/2"	27.5	31	60	Pin Hole
80668524	1/2"	1/2"	27.5	31	60	Lock Pin

## 重工型万向接头 Universal Joints For Heavy Duty Purpose

1/2" Square Drive ■ Universal Joints

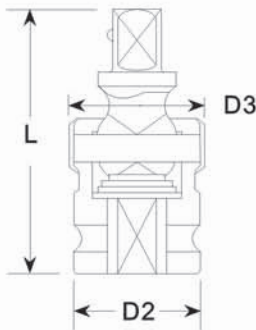

Order No.	□ Inch	■ Inch	D2 mm	D3 mm	L mm	Male End Type
80668527	1/2"	1/2"	30	36	60	Steel Ball
80668528	1/2"	1/2"	30	36	60	Pin Hole
80668529	1/2"	1/2"	30	36	60	Lock Pin



## ▶ 颤动万向头 Wobble Adapter

1/2" Square Drive
  1/2" Square

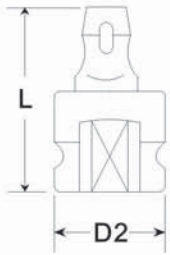

Order No.	D2 mm	L mm	Male End Type
80668585	25	48	Pin Hole

1/4"

P1-10

3/8"

P11-44

1/2"

P45-92

5/8"

P93-94

3/4"

P95-112

## ▶ 转换头 Adapter From Hex. To Male Square

Hex
  1/2" Square

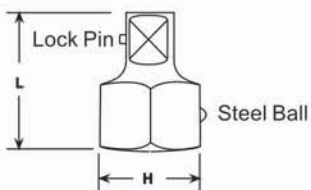

Order No.	Inch	H mm	L mm
80663250	1/2"	10	29
80663251	1/2"	11	29
80663252	1/2"	12	29
80663253	1/2"	13	29
80663254	1/2"	14	29
80663255	1/2"	15	29
80663256	1/2"	16	29
80663257	1/2"	17	29
80663258	1/2"	18	29
80663259	1/2"	19	29
80663261	1/2"	21	29

1"

P113-128

1-1/2"

P129-132

2-1/2"

P133-136

起子套筒

P137-145

起子头

P146-164

装配作业中，实现不同尺寸螺栓装配时，套筒的快速切换。  
 During fastening operation, the adaptor allows the user to activate the quick-release feature between different size bolts.



# NORMECO INDUSTRIAL SOCKETS

- 1/4"
- P1-10
- 3/8"
- P11-44
- 1/2"
- P45-92
- 5/8"
- P93-94
- 3/4"
- P95-112
- 1"
- P113-128
- 1-1/2"
- P129-132
- 2-1/2"
- P133-136
- 起子套筒
- P137-145
- 起子头
- P146-164

## 转换头 1/2" Square Drive Adapter

1/2" Square Drive
  Square

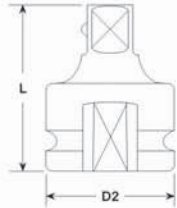

Steel Ball  
钢珠式



Lock Pin  
锁销式



Pin Hole  
销孔式



Order No.	<span style="display: inline-block; width: 10px; height: 10px; border: 1px solid black;"></span> Inch	<span style="display: inline-block; width: 10px; height: 10px; background-color: black;"></span> Inch	D2 mm	L mm	Male End Type
80665210	1/2"	3/8"	25	38	Steel Ball
80665215	1/2"	3/8"	25	75	Steel Ball
80665220	1/2"	3/8"	25	100	Steel Ball
80665225	1/2"	3/8"	25	125	Steel Ball
80665230	1/2"	3/8"	25	150	Steel Ball
80665235	1/2"	3/8"	25	200	Steel Ball
80665240	1/2"	3/8"	25	250	Steel Ball

Order No.	<span style="display: inline-block; width: 10px; height: 10px; border: 1px solid black;"></span> Inch	<span style="display: inline-block; width: 10px; height: 10px; background-color: black;"></span> Inch	D2 mm	L mm	Male End Type
80665245	1/2"	3/8"	25	38	Lock Pin
80665250	1/2"	3/8"	25	75	Lock Pin
80665255	1/2"	3/8"	25	100	Lock Pin
80665260	1/2"	3/8"	25	125	Lock Pin
80665265	1/2"	3/8"	25	150	Lock Pin
80665270	1/2"	3/8"	25	200	Lock Pin
80665275	1/2"	3/8"	25	250	Lock Pin

Order No.	<span style="display: inline-block; width: 10px; height: 10px; border: 1px solid black;"></span> Inch	<span style="display: inline-block; width: 10px; height: 10px; background-color: black;"></span> Inch	D2 mm	L mm	Male End Type
80665280	1/2"	3/8"	25	38	Pin Hole
80665285	1/2"	3/8"	25	75	Pin Hole
80665290	1/2"	3/8"	25	100	Pin Hole
80665295	1/2"	3/8"	25	125	Pin Hole
80665300	1/2"	3/8"	25	150	Pin Hole
80665305	1/2"	3/8"	25	200	Pin Hole
80665310	1/2"	3/8"	25	250	Pin Hole

Order No.	<span style="display: inline-block; width: 10px; height: 10px; border: 1px solid black;"></span> Inch	<span style="display: inline-block; width: 10px; height: 10px; background-color: black;"></span> Inch	D2 mm	L mm	Male End Type
80665315	1/2"	3/4"	30	48	Steel Ball
80665320	1/2"	3/4"	30	48	Lock Pin
80665325	1/2"	3/4"	30	48	Pin Hole



▶ 转换头 1/2" Square Drive Bit Holders

1/2" Square Drive
  HEX 1/4"

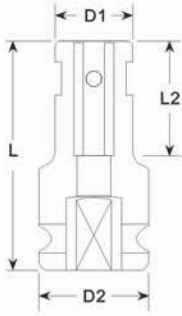

Order No.	Inch	D2 mm	D1 mm	L2 mm	L mm
80668020	1/2"	25	12	23	50

1/4"

P11-10

3/8"

P11-44

1/2"

P45-92

5/8"

P93-94

3/4"

P95-112

▶ 转换头 1/2" Square Drive Bit Holders

1/2" Square Drive
  Hex 1/4"

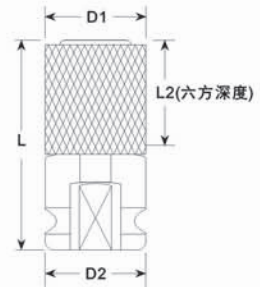

Order No.	Inch	D2 mm	D1 mm	L2 mm	L mm
80668025	1/4"	25	19	23	54

1"

P113-128

1-1/2"

P129-132

2-1/2"

P133-136

起子套筒

P137-145

起子头

P146-164



# NORMECO INDUSTRIAL SOCKETS

1/4"	P1-10
3/8"	P11-44
1/2"	P45-92
5/8"	P93-94
3/4"	P95-112
1"	P113-128
1-1/2"	P129-132
2-1/2"	P133-136
起子套筒	P137-145
起子头	P146-164

▶ 非标准套筒 Custom-Made Sockets

Special Parts Applications

**NORMECO**® 双方向轴套筒



**NORMECO**® 开口式起子套筒



**NORMECO**®  
8-point sockets-double square



**NORMECO**®  
1-1/2" 销孔式延长杆



2-1/2"

P133-136

起子套筒

P137-145

起子头

P146-164





▶ NORMECO套筒应用

Special Parts Applications

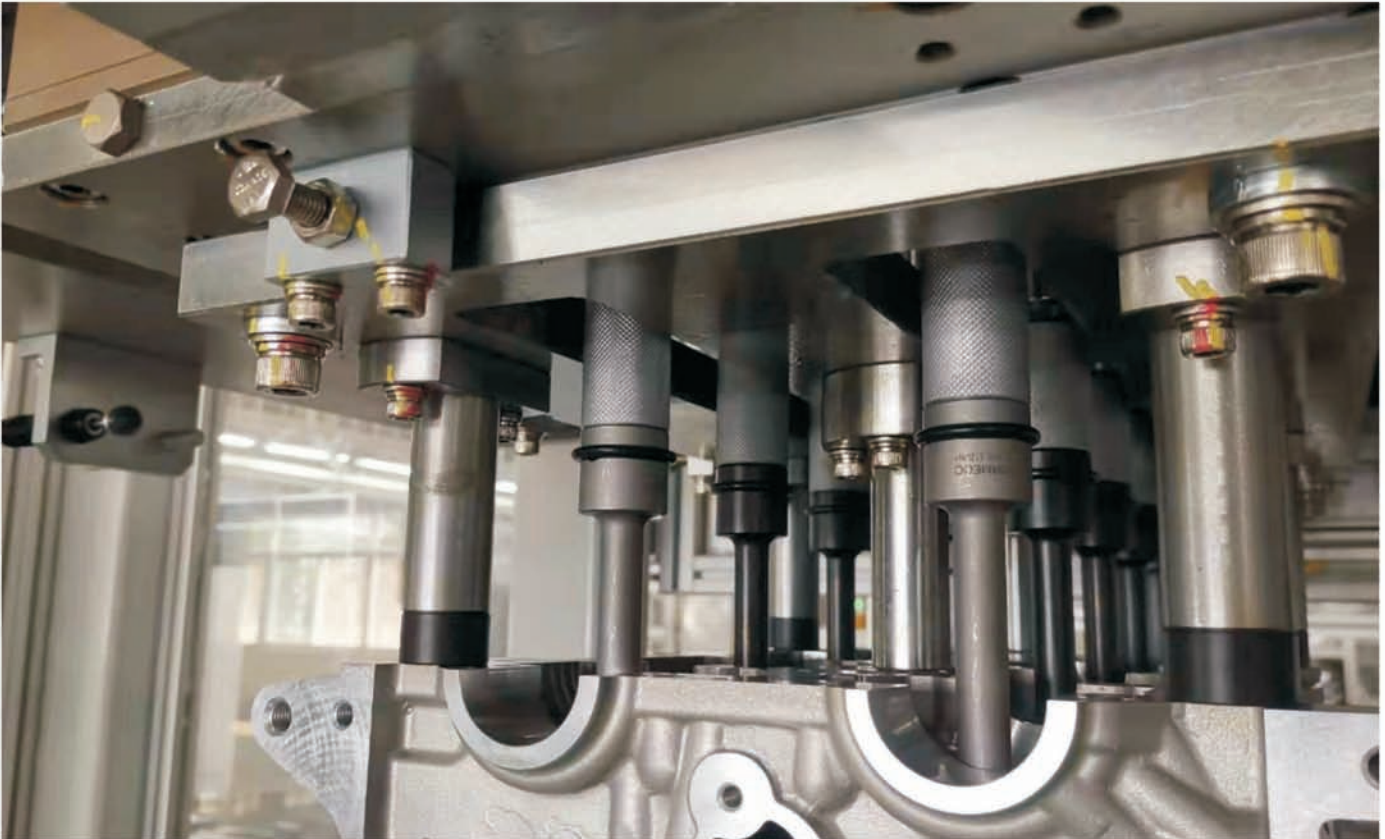

1/4"

P1-10



3/8"

P11-44



1/2"

P45-92



5/8"

P93-94



3/4"

P95-112



1"

P113-128



1-1/2"

P129-132



2-1/2"

P133-136



起子套筒

P137-145

起子头

P146-164



# NORMECO INDUSTRIAL SOCKETS

## ▶ NORMECO精密制造

1/4"

P1-10

3/8"

P11-44

1/2"

P45-92

5/8"

P93-94

3/4"

P95-112

1"

P113-128

1-1/2"

P129-132

2-1/2"

P133-136

起子套筒

P137-145

起子头

P146-164

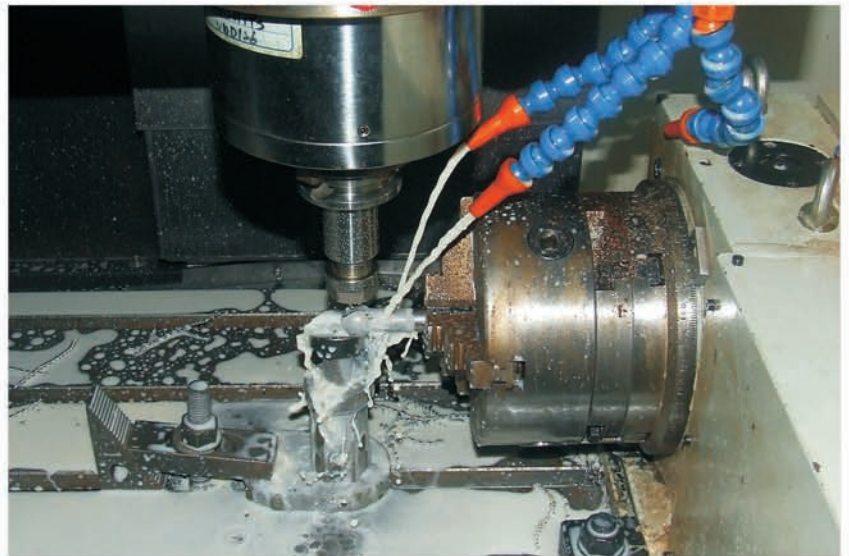

# NORMECO INDUSTRIAL SOCKETS



## 转换头 Adapter

  5/8" Square Drive   
  Square

Order No.	<span style="border: 1px solid black; border-radius: 50%; padding: 2px;"> </span> Inch	<span style="display: inline-block; width: 10px; height: 10px; background-color: black; margin-right: 5px;"></span> Inch	D2 mm	L mm	Male End Type
80665410	5/8"	1/2"	34	50	Steel Ball
80665430	5/8"	1/2"	34	50	Lock Pin
80665450	5/8"	1/2"	34	50	Pin Hole

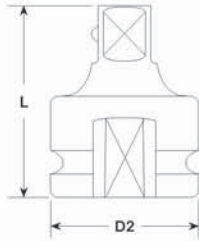

Steel Ball  
钢珠式



Lock Pin  
锁销式



Pin Hole  
销孔式



  1/4"

P1-10

  3/8"

P11-44

  1/2"

P45-92

  5/8"

P93-94

  3/4"

P95-112

  1"

P113-128

  1-1/2"

P129-132

  2-1/2"

P133-136

  起子套筒

P137-145

起子头

P146-164



# NORMECO INDUSTRIAL SOCKETS

1/4"
P1-10
3/8"
P11-44
1/2"
P45-92
5/8"
P93-94
3/4"
P95-112
1"
P113-128
1-1/2"
P129-132
2-1/2"
P133-136
起子套筒
P137-145
起子头
P146-164

## 六角标准套筒 6-Point Sockets

3/4" Square Drive 6-Point Sockets

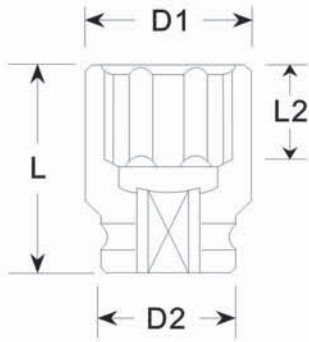

Order No.	Inch	D2 mm	D1 mm	L2 mm	L mm
80130508	1/2"	38	22	9	50
80130509	9/16"	38	25.5	11	50
80130510	5/8"	38	27.5	11	50
80130511	11/16"	38	29	12	50
80130512	3/4"	38	30	13	50
80130513	13/16"	38	32	15	52
80130514	7/8"	38	34	15	52
80130515	15/16"	38	36	16	52
80130516	1"	40	40	16	52
80130517	1-1/16"	40	40	19	52
80130518	1-1/8"	42	42	21	52
80130519	1-3/16"	44	47	21	52
80130520	1-1/4"	44	49	22	56
80130521	1-5/16"	44	52	22	56
80130522	1-3/8"	44	53	22	56
80130523	1-7/16"	44	54	25	58
80130524	1-1/2"	44	55	25	58
80130525	1-9/16"	44	56	25	62
80130526	1-5/8"	44	58	27	62
80130527	1-11/16"	44	63.5	27	62
80130528	1-3/4"	44	65	27	62
80130529	1-13/16"	44	67	30	68
80130530	1-7/8"	44	68	30	68
80130531	1-15/16"	44	70	30	70
80130532	2"	54	71	32	72
80130533	2-1/16"	54	74	32	72
80130534	2-1/8"	54	77	32	72

Order No.	Size mm	D2 mm	D1 mm	L2 mm	L mm
80130013	13	38	22	9	50
80130014	14	38	25.5	11	50
80130015	15	38	26	11	50
80130016	16	38	27.5	11	50
80130017	17	38	28.5	12	50
80130018	18	38	29.5	13	50
80130019	19	38	30	13	50
80130020	20	38	31	14	52
80130021	21	38	32	15	52
80130022	22	38	34	15	52
80130023	23	38	35	16	52
80130024	24	38	36	16	52
80130025	25	38	38	16	52
80130026	26	44	40	16	52
80130027	27	44	40	19	52
80130028	28	44	42	19	52
80130029	29	44	42	21	52
80130030	30	44	47	21	54
80130031	31	44	48	21	56
80130032	32	44	49	22	56
80130033	33	44	51	22	56
80130034	34	44	52	22	56
80130035	35	44	53	22	56
80130036	36	44	54	25	58
80130037	37	44	56	25	58
80130038	38	44	57	25	58
80130041	41	44	60	27	58
80130046	46	44	67	30	63
80130050	50	54	71	32	72
80130055	55	54	77	35	74
80130060	60	54	84	37	75
80130065	65	54	88	40	78
80130070	70	54	96	40	80





## 六角重工型套筒 6-Point Sockets For Heavy Duty

3/4" Square Drive 6-Point Sockets

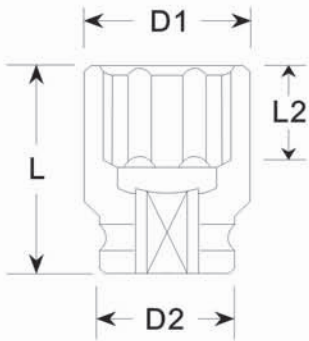

Order No.	Size mm	D2 mm	D1 mm	L2 mm	L mm
80130313	13	44	25	9	50
80130314	14	44	26.5	11	50
80130315	15	44	27.5	11	50
80130316	16	44	29	11	50
80130317	17	44	31	12	50
80130318	18	44	32	13	50
80130319	19	44	33	13	50
80130320	20	44	34	14	52
80130321	21	44	35	15	52
80130322	22	44	37	15	52
80130323	23	44	38	16	52
80130324	24	44	39	16	52
80130325	25	44	40	16	52
80130326	26	44	41	16	52
80130327	27	44	43	19	52
80130328	28	44	44	19	52
80130329	29	44	45	21	52
80130330	30	44	48	21	54

## 六角半加长薄壁套筒 6-Point Sockets-Semi Deep & Thin Wall

3/4" Square Drive 6-Point Sockets

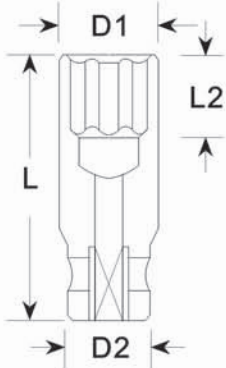

Order No.	Size mm	D2 mm	D1 mm	L2 mm	L mm
80133013	13	38	21	13	65
80133014	14	38	22	14	65
80133015	15	38	23	15	65
80133016	16	38	24	16	65
80133017	17	38	24.5	17	65
80133018	18	38	26	18	65
80133019	19	38	27	19	65
80133020	20	38	28.5	20	65
80133021	21	38	29.5	21	65
80133022	22	38	30.5	22	65
80133023	23	38	31.5	23	65
80133024	24	38	33	24	65
80133025	25	38	36	25	65
80133026	26	38	38	26	80
80133027	27	39	39	27	80
80133028	28	41	41	28	80
80133029	29	42	42	29	80
80133030	30	43	43	30	80
80133031	31	43.5	43.5	31	80
80133032	32	44	44	32	80
80133033	33	44	46	33	80
80133034	34	44	48	34	80
80133035	35	44	50	35	80

1/4"

P1-10

3/8"

P11-44

1/2"

P45-92

5/8"

P93-94

3/4"

P95-112

1"

P113-128

1-1/2"

P129-132

2-1/2"

P133-136

起子套筒

P137-145

起子头

P146-164



# NORMECO INDUSTRIAL SOCKETS

- 1/4" P1-10
- 3/8" P11-44
- 1/2" P45-92
- 5/8" P93-94
- 3/4" P95-112
- 1" P113-128
- 1-1/2" P129-132
- 2-1/2" P133-136
- 起子套筒 P137-145
- 起子头 P146-164

## 六角加长套筒 6-Point Sockets Deep

3/4" Square Drive 6-Point Sockets



Order No.	Inch	D2 mm	D1 mm	L2 mm	L mm
80135508	1/2"	38	22	13	95
80135509	9/16"	38	25.5	14	95
80135510	5/8"	38	27.5	16	95
80135511	11/16"	38	29	17	95
80135512	3/4"	38	30	19	95
80135513	13/16"	38	32	22	95
80135514	7/8"	38	34	22	95
80135515	15/16"	38	36	24	95
80135516	1"	40	40	25	95
80135517	1-1/16"	40	40	27	95
80135518	1-1/8"	42	42	29	95
80135519	1-3/16"	44	47	30	95
80135520	1-1/4"	44	49	32	95
80135521	1-5/16"	44	52	34	95
80135522	1-3/8"	44	53	35	95
80135523	1-7/16"	44	54	36	95
80135524	1-1/2"	44	55	38	95
80135525	1-9/16"	44	56	38	95
80135526	1-5/8"	44	58	38	95
80135527	1-11/16"	44	63.5	38	95
80135528	1-3/4"	44	65	38	95
80135529	1-13/16"	44	67	38	95
80135530	1-7/8"	44	68	38	95
80135531	1-15/16"	44	70	38	95
80135532	2"	54	71	40	95
80135533	2-1/16"	54	74	40	95
80135534	2-1/8"	54	77	40	95

Order No.	Size mm	D2 mm	D1 mm	L2 mm	L mm
80135013	13	44	25	13	95
80135014	14	44	25	14	95
80135015	15	44	26	15	95
80135016	16	44	27	16	95
80135017	17	44	31	17	95
80135018	18	44	32	18	95
80135019	19	44	33	19	95
80135020	20	44	34	20	95
80135021	21	44	35	21	95
80135022	22	44	37	22	95
80135023	23	44	38	23	95
80135024	24	44	39	24	95
80135025	25	44	40	25	95
80135026	26	44	41	26	95
80135027	27	44	43	27	95
80135028	28	44	44	28	95
80135029	29	44	45	29	95
80135030	30	44	47	30	95
80135031	31	44	48	31	95
80135032	32	44	49	32	95
80135033	33	44	51	33	95
80135034	34	44	52	34	95
80135035	35	44	53	35	95
80135036	36	44	54	36	95
80135037	37	44	56	37	95
80135038	38	44	57	38	95
80135041	41	44	60	38	95
80135046	46	44	67	38	95
80135050	50	54	71	38	95
80135055	55	54	77	40	100
80135060	60	54	84	42	105
80135065	65	54	88	46	105
80135070	70	54	96	46	105

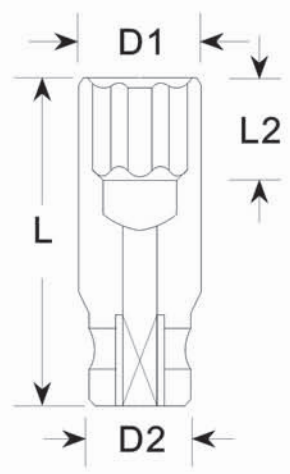

# NORMECO INDUSTRIAL SOCKETS



## 六角薄壁加长套筒 6-Point Sockets-Deep & Thin Wall

 3/4" Square Drive
  6-Point Sockets

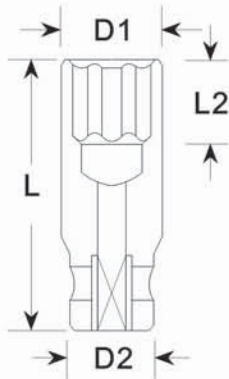

Order No.	Size mm	D2 mm	D1 mm	L2 mm	L mm
80135613	13	38	22	13	95
80135614	14	38	23	14	95
80135615	15	38	24	15	95
80135616	16	38	24.5	16	95
80135617	17	38	25.5	17	95
80135618	18	38	27	18	95
80135619	19	38	28.5	19	95
80135620	20	38	30	20	95
80135621	21	38	32	21	95
80135622	22	38	33.5	22	95
80135623	23	38	35	23	95
80135624	24	44	36.5	24	95
80135625	25	44	38	25	95
80135626	26	44	39.5	26	95
80135627	27	44	40.5	27	95
80135628	28	44	41.5	28	95
80135629	29	44	42.5	29	95
80135630	30	44	43.5	30	95
80135631	31	44	45	31	95
80135632	32	44	46.5	32	95
80135633	33	44	47.5	33	95
80135634	34	44	49	34	95
80135635	35	44	51	35	95
80135636	36	44	52	36	95
80135637	37	44	53	37	95
80135638	38	44	54	38	95
80135641	41	44	57	38	95



	1/4"
	P1-10
	3/8"
	P11-44
	1/2"
	P45-92
	5/8"
	P93-94
	3/4"
	P95-112
	1"
	P113-128
	1-1/2"
	P129-132
	2-1/2"
	P133-136
	起子套筒
	P137-145
	起子头
	P146-164



# NORMECO INDUSTRIAL SOCKETS

- 1/4" P1-10
- 3/8" P11-44
- 1/2" P45-92
- 5/8" P93-94
- 3/4" P95-112
- 1" P113-128
- 1-1/2" P129-132
- 2-1/2" P133-136
- 起子套筒 P137-145
- 起子头 P146-164

## 六角套筒 6-Point Sockets

3/4" Square Drive
 6-Point Sockets

● 维修级 Maintenance Purpose

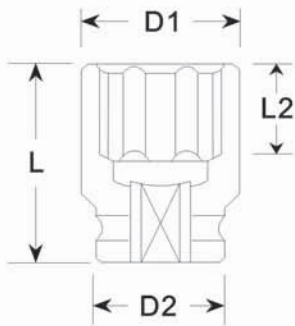

Order No.	Size mm	D2 mm	D1 mm	L2 mm	L mm
80132017	17	38	28.5	12	50
80132018	18	38	29.5	13	50
80132019	19	38	30	13	50
80132021	21	38	32	15	52
80132022	22	38	34	15	52
80132024	24	38	36	16	52
80132027	27	40	40	19	52
80132030	30	44	47	21	54
80132032	32	44	49	22	56
80132033	33	44	51	22	56
80132034	34	44	52	22	56
80132036	36	44	54	25	56
80132038	38	44	57	25	58
80132041	41	44	60	27	58
80132046	46	44	66	30	63
80132050	50	44	71	32	72
80132055	55	44	75	35	74

Order No.	Size mm	D2 mm	D1 mm	L2 mm	L mm
80138017	17	38	29	19	80
80138018	18	38	30	19	80
80138019	19	38	32	22	80
80138021	21	38	34	22	80
80138022	22	39	36	24	80
80138024	24	39	39	24	80
80138027	27	42	42	27	80
80138030	30	44	46	30	80
80138032	32	44	48	32	80
80138034	34	44	51	34	80
80138036	36	44	53	36	80
80138038	38	44	56	38	80
80138041	41	44	60	42	80
80138046	46	44	66	46	95
80138050	50	44	71	50	100
80138055	55	44	75	60	110

● 维修级 Maintenance Purpose  
 维修级产品适用于维修、家居及工作室等较低使用频次及使用强度的场所。  
 Maintenance-grade products are suitable for working situation with low frequency and intensity of use, such as maintenance, DIY and studio.



## 六角大圆弧标准套筒 Surface Drive 6-Point Sockets

3/4" Square Drive
 Surface Drive 6-Point

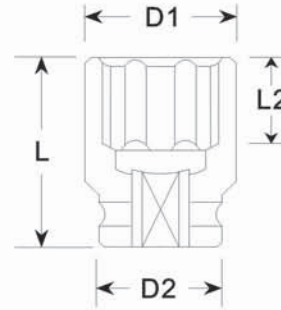

Order No.	Size mm	D2 mm	D1 mm	L2 mm	L mm
80465619	19	38	31	13	50
80465621	21	38	33	15	52
80465622	22	38	34	15	52
80465623	23	38	35	16	52
80465624	24	38	36	16	52
80465625	25	38	38	16	52
80465626	26	44	40	16	52
80465627	27	44	40	19	52
80465628	28	44	42	19	52
80465629	29	44	43	21	52
80465630	30	44	44	21	54
80465631	31	44	45	21	56
80465632	32	44	46	22	56
80465634	34	44	48	22	56
80465636	36	44	50	25	56

1/4"

P1-10

3/8"

P11-44

1/2"

P45-92

5/8"

P93-94

3/4"

P95-112

## 六角大圆弧加长套筒 Surface Drive 6-Point Sockets-Deep

3/4" Square Drive
 Surface Drive 6-Point

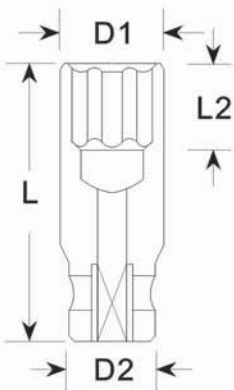

Order No.	Size mm	D2 mm	D1 mm	L2 mm	L mm
80465719	19	44	31	19	95
80465721	21	44	33	21	95
80465722	22	44	34	22	95
80465723	23	44	35	23	95
80465724	24	44	36	24	95
80465725	25	44	38	25	95
80465726	26	44	40	26	95
80465727	27	44	40	27	95
80465728	28	44	42	28	95
80465729	29	44	43	29	95
80465730	30	44	44	30	95
80465731	31	44	45	31	95
80465732	32	44	46	32	95
80465734	34	44	48	34	95
80465736	36	44	50	36	95

1"

P113-128

1-1/2"

P129-132

2-1/2"

P133-136

起子套筒

P137-145

起子头

P146-164



# NORMECO INDUSTRIAL SOCKETS

1/4"
P1-10
3/8"
P11-44
1/2"
P45-92
5/8"
P93-94
3/4"
P95-112
1"
P113-128
1-1/2"
P129-132
2-1/2"
P133-136
起子套筒
P137-145
起子头
P146-164

## 十二角标准套筒 12-Point Sockets

3/4" Square Drive 12-Point Sockets



Order No.	Size Inch	D2 mm	D1 mm	L2 mm	L mm
80230516	1/2"	44	24.5	9	50
80230518	9/16"	44	25.5	11	50
80230520	5/8"	44	28	11	50
80230522	11/16"	44	31.5	12	50
80230524	3/4"	44	33	13	50
80230526	13/16"	44	35	15	50
80230528	7/8"	44	37	15	50
80230530	15/16"	44	39	18	50
80230532	1"	44	41	18	50
80230534	1-1/16"	44	43	19	54
80230536	1-1/8"	44	44.5	21	54
80230538	1-3/16"	44	47	21	54
80230540	1-1/4"	44	49	22	56
80230542	1-5/16"	44	51	22	56
80230544	1-3/8"	44	53	22	56
80230546	1-7/16"	44	55	25	56
80230548	1-1/2"	44	57	25	58
80230550	1-9/16"	44	59	25	58
80230552	1-5/8"	44	61	27	58
80230554	1-11/16"	44	63.5	27	63
80230556	1-3/4"	44	64.5	27	63
80230558	1-13/16"	44	67	30	63
80230560	1-7/8"	44	68	30	68
80230562	1-15/16"	54	70	30	70
80230564	2"	54	72	32	72
80230566	2-1/16"	54	74	32	72
80230568	2-1/8"	54	77	32	72
80230570	2-3/16"	54	78.5	35	74
80230572	2-1/4"	54	80	35	74
80230574	2-5/16"	54	82	37	75
80230576	2-3/8"	54	84	37	75

Order No.	Size mm	D2 mm	D1 mm	L2 mm	L mm
80230013	13	38	24.5	9	50
80230014	14	38	25.5	11	50
80230015	15	38	27	11	50
80230016	16	38	28	11	50
80230017	17	44	31	12	50
80230018	18	44	32	13	50
80230019	19	44	32	13	50
80230020	20	44	33	14	52
80230021	21	44	35	15	52
80230022	22	44	37	15	52
80230023	23	44	38	16	52
80230024	24	44	39	18	52
80230025	25	44	41	18	52
80230026	26	44	42	18	52
80230027	27	44	43	19	54
80230028	28	44	44	19	54
80230029	29	44	45	21	54
80230030	30	44	47	21	54
80230031	31	44	48	21	56
80230032	32	44	49	22	56
80230033	33	44	51	22	56
80230034	34	44	52	22	56
80230035	35	44	53	22	56
80230036	36	44	54	25	56
80230037	37	44	56	25	58
80230038	38	44	57	25	58
80230041	41	44	60	27	58
80230046	46	44	67	30	63
80230050	50	54	71	32	72
80230055	55	54	78	35	74
80230060	60	54	84	37	75

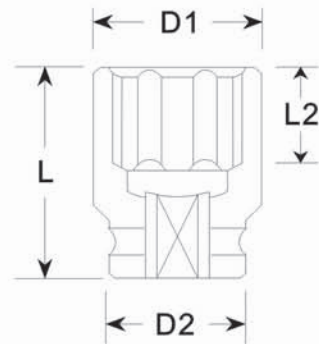

# NORMECO INDUSTRIAL SOCKETS



## 十二角加长套筒 12-Point Sockets-Deep Length

 3/4" Square Drive
  12-Point Sockets



Order No.	Size Inch	D2 mm	D1 mm	L2 mm	L mm
80235516	1/2"	44	24.5	13	95
80235518	9/16"	44	25.5	14	95
80235520	5/8"	44	28	16	95
80235522	11/16"	44	31.5	17	95
80235524	3/4"	44	33	19	95
80235526	13/16"	44	35	22	95
80235528	7/8"	44	37	22	95
80235530	15/16"	44	39	24	95
80235532	1"	44	41	25	95
80235534	1-1/16"	44	43	27	95
80235536	1-1/8"	44	44.5	29	95
80235538	1-3/16"	44	47	30	95
80235540	1-1/4"	44	49	32	95
80235542	1-5/16"	44	51	34	95
80235544	1-3/8"	44	53	35	95
80235546	1-7/16"	44	55	37	95
80235548	1-1/2"	44	57	38	95
80235550	1-9/16"	44	59	38	95
80235552	1-5/8"	44	61	38	95
80235554	1-11/16"	44	63.5	38	95
80235556	1-3/4"	44	64.5	38	95
80235558	1-13/16"	44	67	38	100
80235560	1-7/8"	44	68	38	100
80235562	1-15/16"	44	70	38	100
80235564	2"	54	72	40	100
80235566	2-1/16"	54	74	40	100
80235568	2-1/8"	54	77	40	100
80235570	2-3/16"	54	78.5	40	105
80235572	2-1/4"	54	80	40	105
80235574	2-5/16"	54	82	40	105
80235576	2-3/8"	54	84	42	105

Order No.	Size mm	D2 mm	D1 mm	L2 mm	L mm
80235013	13	38	24.5	13	95
80235014	14	38	25.5	14	95
80235015	15	38	27	15	95
80235016	16	38	28	16	95
80235017	17	44	31	17	95
80235018	18	44	32	18	95
80235019	19	44	33	19	95
80235020	20	44	33	20	95
80235021	21	44	35	21	95
80235022	22	44	37	22	95
80235023	23	44	38	23	95
80235024	24	44	39	24	95
80235025	25	44	41	25	95
80235026	26	44	42	26	95
80235027	27	44	43	27	95
80235028	28	44	44	28	95
80235029	29	44	45	29	95
80235030	30	44	47	30	95
80235031	31	44	48	31	95
80235032	32	44	49	32	95
80235033	33	44	51	33	95
80235034	34	44	52	34	95
80235035	35	44	53	35	95
80235036	36	44	54	36	95
80235037	37	44	56	37	95
80235038	38	44	57	38	95
80235041	41	44	60	38	95
80235046	46	44	67	38	100
80235050	50	54	71	38	100
80235055	55	54	78	40	105
80235060	60	54	84	42	105
80235065	65	54	90	66	105
80235070	70	54	96	66	105
80235075	75	54	102	68	108

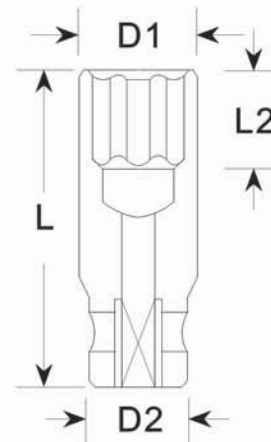

	1/4"
P1-10	
	3/8"
P11-44	
	1/2"
P45-92	
	5/8"
P93-94	
	3/4"
P95-112	
	1"
P113-128	
	1-1/2"
P129-132	
	2-1/2"
P133-136	
	起子套筒
P137-145	
	起子头
P146-164	



# NORMECO INDUSTRIAL SOCKETS

- 1/4" P1-10
- 3/8" P11-44
- 1/2" P45-92
- 5/8" P93-94
- 3/4" P95-112
- 1" P113-128
- 1-1/2" P129-132
- 2-1/2" P133-136
- 起子套筒 P137-145
- 起子头 P146-164

## 外星型标准套筒 External Torx

3/4" Square Drive External Torx

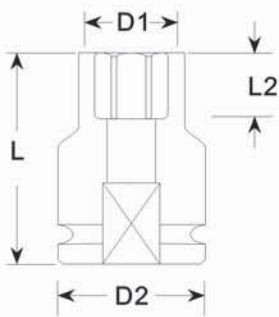

Order No.		D2 mm	D1 mm	L2 mm	L mm
80176116	E16	44	22	13	56
80176118	E18	44	25	15	56
80176120	E20	44	27	15	56
80176122	E22	44	30	19	56
80176124	E24	44	33	19	56

## 外星型加长套筒 External Torx Sockets-Deep Length

3/4" Square Drive External Torx

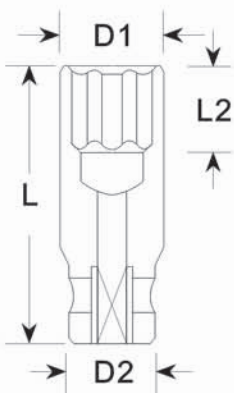

Order No.		D2 mm	D1 mm	L2 mm	L mm
80176316	E16	44	22	13	110
80176318	E18	44	25	15	110
80176320	E20	44	27	15	110
80176322	E22	44	30	19	110
80176324	E24	44	33	19	110



▶ 双头螺栓套筒 Stud Bolt Impact Sockets

 3/4" Square Drive
  Stud Bolt

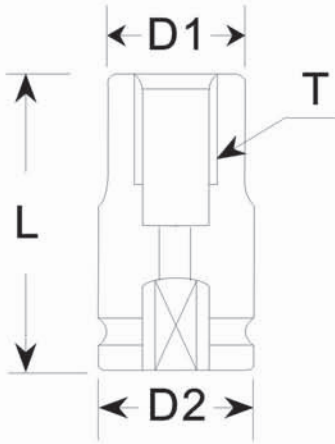

Order No.	T	D2 mm	D1 mm	L mm
80182715	M16×P1.5	44	29	100
80182717	M16×P2.0	44	29	100
80182720	M18×P2.0	44	31	100
80182721	M18×P2.5	44	31	100
80182723	M20×P2.0	44	33	100
80182725	M20×P2.5	44	33	100
80182725A	M22×P1.5	44	35	100
80182726	M22×P2.5	44	35	100
80182730	M24×P3.0	44	37	100
80182732	M27×P3.0	44	40	100
80182736	M30×P2.0	44	43	100
80182738	M30×P3.5	44	43	100
80182742	M32×P2.0	44	46	100
80182746	M36×P3.0	44	51	100
80182748	M36×P4.0	44	51	100
80182786	5/8"-11UNC	44	30	100
80182789	3/4"-10UNC	44	32	100
80182792	7/8"-9UNC	44	34	100

	1/4"
	P1-10
	3/8"
	P11-44
	1/2"
	P45-92
	5/8"
	P93-94
	3/4"
	P95-112
	1"
	P113-128
	1-1/2"
	P129-132
	2-1/2"
	P133-136
	起子套筒
	P137-145
	起子头
	P146-164



# NORMECO INDUSTRIAL SOCKETS

- 1/4" P1-10
- 3/8" P11-44
- 1/2" P45-92
- 5/8" P93-94
- 3/4" P95-112
- 1" P113-128
- 1-1/2" P129-132
- 2-1/2" P133-136
- 起子套筒 P137-145
- 起子头 P146-164

## 四方标准套筒 4-Point Female Sockets

3/4" Square Drive 4-Point Female

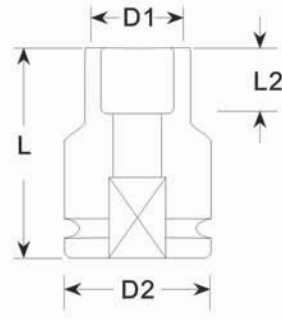

Order No.	Size	Size mm	D2 mm	D1 mm	L2 mm	L mm
80178610	3/4"	5/8"	40	32	13	52
80178612	3/4"	11/16"	40	34	13	52
80178616	3/4"	13/16"	42	42	15	52

## 八角标准套筒 8-Point Sockets-Double Square

3/4" Square Drive Double Square

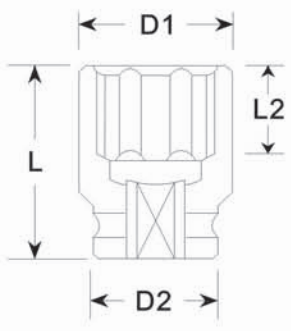

Order No.	Size mm	D2 mm	D1 mm	L2 mm	L mm
80466D19	19	40	40	13	50
80466D20	20	41	41	13	50
80466D21	21	42	42	15	50
80466D22	22	44	44	15	50
80466D23	23	44	45	15	50
80466D24	24	44	46.5	18	52
80466D25	25	44	49	18	52
80466D26	26	44	51	18	52
80466D27	27	44	53	19	54
80466D28	28	44	55	19	54
80466D29	29	44	57	19	54
80466D30	30	44	58	21	54
80466D31	31	44	60	21	56
80466D32	32	44	61	22	56
80466D33	33	44	63.5	22	56
80466D34	34	44	65	22	56
80466D35	35	44	66	22	56
80466D36	36	44	67.5	24	56
80466D37	37	44	69	24	58
80466D38	38	44	70	24	58

Order No.	Size inch	D2 mm	D1 mm	L2 mm	L mm
80466B20	5/8"	40	32	13	50
80466B22	11/16"	40	34	13	50
80466B24	3/4"	40	40	13	50
80466B26	13/16"	42	42	15	50
80466B28	7/8"	44	44	15	50
80466B30	15/16"	44	46	18	52
80466B32	1"	44	50	18	52
80466B34	1-1/16"	44	53	19	54
80466B36	1-1/8"	44	56	19	54
80466B38	1-3/16"	44	58	21	54
80466B40	1-1/4"	44	61	22	56
80466B42	1-5/16"	44	63.5	22	56
80466B44	1-3/8"	44	66	22	56
80466B46	1-7/16"	44	68	24	56
80466B48	1-1/2"	44	70	24	58

# NORMECO INDUSTRIAL SOCKETS



## 八角加长套筒 8-Point Sockets-Double Square-Deep



3/4 " Square Drive



Double Square

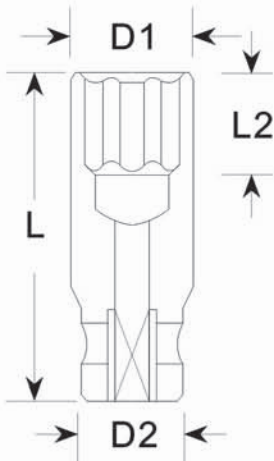

Order No.	Size mm	D2 mm	D1 mm	L2 mm	L mm
80466H19	19	40	40	13	95
80466H20	20	41	41	13	95
80466H21	21	42	42	15	95
80466H22	22	44	44	15	95
80466H23	23	44	45	15	95
80466H24	24	44	46.5	18	95
80466H25	25	44	49	18	95
80466H26	26	44	51	18	95
80466H27	27	44	53	19	95
80466H28	28	44	55	19	95
80466H29	29	44	57	19	95
80466H30	30	44	58	21	95
80466H31	31	44	60	21	95
80466H32	32	44	61	22	95
80466H33	33	44	63.5	22	95
80466H34	34	44	65	22	95
80466H35	35	44	66	22	95
80466H36	36	44	67.5	24	95
80466H37	37	44	69	24	95
80466H38	38	44	70	24	95

Order No.	Size inch	D2 mm	D1 mm	L2 mm	L mm
80466F24	3/4 "	40	40	13	95
80466F26	13/16 "	42	42	15	95
80466F28	7/8 "	44	44	15	95
80466F30	15/16 "	44	46	18	95
80466F32	1 "	44	50	18	95
80466F34	1-1/16 "	44	53	19	95
80466F36	1-1/8 "	44	56	19	95
80466F38	1-3/16 "	44	58	21	95
80466F40	1-1/4 "	44	61	22	95
80466F42	1-5/16 "	44	63.5	22	95
80466F44	1-3/8 "	44	66	22	95
80466F46	1-7/16 "	44	68	24	95
80466F48	1-1/2 "	44	70	24	95



1/4 "



P1-10



3/8 "



P11-44



1/2 "



P45-92



5/8 "



P93-94



3/4 "



P95-112



1 "



P113-128



1-1/2 "



P129-132



2-1/2 "



P133-136



起子套筒



P137-145



起子头



P146-164



# NORMECO INDUSTRIAL SOCKETS

- 1/4" P1-10
- 3/8" P11-44
- 1/2" P45-92
- 5/8" P93-94
- 3/4" P95-112
- 1" P113-128
- 1-1/2" P129-132
- 2-1/2" P133-136
- P137-145
- P146-164

## 内六角套筒 Male Hex Drive Sockets

3/4" Square Drive Hex

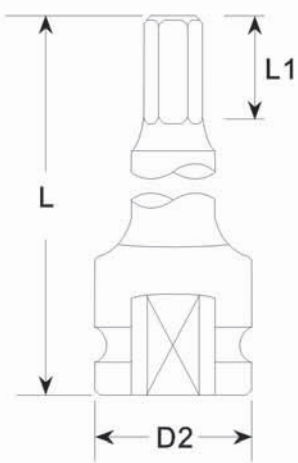

Order No.	Size mm	D2 mm	L1 mm	L mm
80560010	10	44	15	62
80560011	11	44	15	62
80560012	12	44	15	62
80560013	13	44	20	62
80560014	14	44	20	62
80560015	15	44	20	62
80560016	16	44	20	62
80560017	17	44	20	62
80560018	18	44	20	62
80560019	19	44	20	62
80560020	20	44	20	62
80560021	21	44	20	62
80560022	22	44	20	62
80560024	24	44	20	62
80560025	25	44	20	62
80560026	26	44	20	62
80560027	27	44	20	62
80560028	28	44	20	62
80560029	29	44	20	62
80560030	30	44	20	62
80560032	32	44	20	62
80560034	34	44	20	62
80560036	36	44	20	62
80560038	38	44	20	62

Order No.	Size inch	D2 mm	L1 mm	L mm
80562012	3/8"	44	15	62
80562014	7/16"	44	15	62
80562016	1/2"	44	15	62
80562018	9/16"	44	20	62
80562020	5/8"	44	20	62
80562022	11/16"	44	20	62
80562024	3/4"	44	20	62
80562026	13/16"	44	20	62
80562028	7/8"	44	20	62
80562030	15/16"	44	20	62
80562100	1"	44	20	62
80562102	1-1/16"	44	20	62
80562104	1-1/8"	44	20	62
80562106	1-3/16"	44	20	62
80562108	1-1/4"	44	20	62

# NORMECO INDUSTRIAL SOCKETS



## ▶ 内六角套筒 Male Hex Drive Sockets

 3/4" Square Drive
  Hex

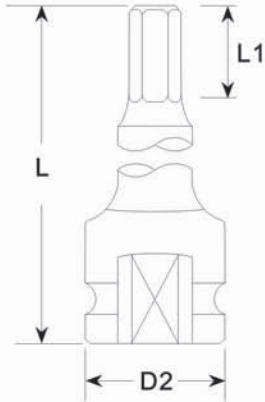

Order No.	● Size mm	D2 mm	L1 mm	L mm
80565010	10	44	20	100
80565011	11	44	20	100
80565012	12	44	20	100
80565013	13	44	20	100
80565014	14	44	20	100
80565015	15	44	20	100
80565016	16	44	20	100
80565017	17	44	20	100
80565018	18	44	20	100
80565019	19	44	20	100
80565020	20	44	20	100
80565021	21	44	20	100
80565022	22	44	20	100
80565024	24	44	20	100
80565025	25	44	20	100
80565026	26	44	20	100
80565027	27	44	20	100
80565028	28	44	20	100
80565029	29	44	20	100
80565030	30	44	28	100
80565032	32	44	28	100
80565034	34	44	28	100
80565036	36	44	28	100
80565038	38	44	28	100
80565046	46	44	28	100
80565055	55	50	28	100

Order No.	● Size inch	D2 mm	L1 mm	L mm
80566012	3/8"	44	20	100
80566014	7/16"	44	20	100
80566016	1/2"	44	20	100
80566018	9/16"	44	20	100
80566020	5/8"	44	20	100
80566022	11/16"	44	20	100
80566024	3/4"	44	20	100
80566026	13/16"	44	20	100
80566028	7/8"	44	20	100
80566030	15/16"	44	20	100
80566100	1"	44	20	100
80566102	1-1/16"	44	20	100
80566104	1-1/8"	44	20	100
80566106	1-3/16"	44	20	100
80566108	1-1/4"	44	20	100

	1/4"
	P11-10
	3/8"
	P11-44
	1/2"
	P45-92
	5/8"
	P93-94
	3/4"
	P95-112
	1"
	P113-128
	1-1/2"
	P129-132
	2-1/2"
	P133-136
	起子套筒
	P137-145
	起子头
	P146-164



# NORMECO INDUSTRIAL SOCKETS

- 1/4" P1-10
- 3/8" P11-44
- 1/2" P45-92
- 5/8" P93-94
- 3/4" P95-112
- 1" P113-128
- 1-1/2" P129-132
- 2-1/2" P133-136
- 起子套筒 P137-145
- 起子头 P146-164

## ▶ 延长杆 Extension Bars

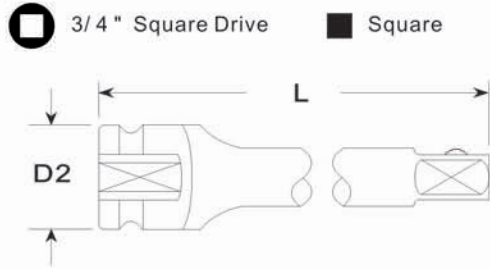

Order No.	□ Inch	■ Inch	D2 mm	L mm	Male End Type
80631075	3/4"	3/4"	44	75	Steel Ball
80631100	3/4"	3/4"	44	100	Steel Ball
80631125	3/4"	3/4"	44	125	Steel Ball
80631150	3/4"	3/4"	44	150	Steel Ball
80631175	3/4"	3/4"	44	175	Steel Ball
80631200	3/4"	3/4"	44	200	Steel Ball
80631250	3/4"	3/4"	44	250	Steel Ball
80631300	3/4"	3/4"	44	300	Steel Ball
80631400	3/4"	3/4"	44	400	Steel Ball

Order No.	□ Inch	■ Inch	D2 mm	L mm	Male End Type
80633075	3/4"	3/4"	44	75	Lock Pin
80633100	3/4"	3/4"	44	100	Lock Pin
80633125	3/4"	3/4"	44	125	Lock Pin
80633150	3/4"	3/4"	44	150	Lock Pin
80633175	3/4"	3/4"	44	175	Lock Pin
80633200	3/4"	3/4"	44	200	Lock Pin
80633250	3/4"	3/4"	44	250	Lock Pin
80633300	3/4"	3/4"	44	300	Lock Pin
80633400	3/4"	3/4"	44	400	Lock Pin

Order No.	□ Inch	■ Inch	D2 mm	L mm	Male End Type
80635075	3/4"	3/4"	44	75	Pin Hole
80635100	3/4"	3/4"	44	100	Pin Hole
80635125	3/4"	3/4"	44	125	Pin Hole
80635150	3/4"	3/4"	44	150	Pin Hole
80635175	3/4"	3/4"	44	175	Pin Hole
80635200	3/4"	3/4"	44	200	Pin Hole
80635250	3/4"	3/4"	44	250	Pin Hole
80635300	3/4"	3/4"	44	300	Pin Hole
80635400	3/4"	3/4"	44	400	Pin Hole

## ▶ 快换式延长杆 Quick-Change Extension Bars

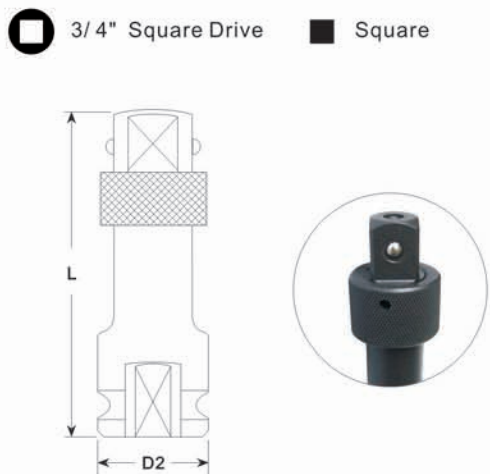

Order No.	□ Inch	■ Inch	D2 mm	L mm	Male End Type
80635C10	3/4"	3/4"	44	78	Steel Ball
80635C15	3/4"	3/4"	44	125	Steel Ball
80635C20	3/4"	3/4"	44	150	Steel Ball
80635C25	3/4"	3/4"	44	200	Steel Ball
80635C30	3/4"	3/4"	44	250	Steel Ball
80635C35	3/4"	3/4"	44	300	Steel Ball
80635C40	3/4"	3/4"	44	400	Steel Ball





## 快换式转换杆 Quick-Change Adapter

3/4" Square Drive ■ Square

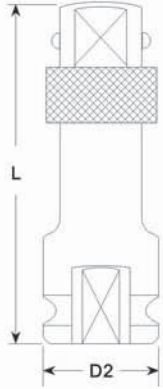

Order No.	□ Inch	■ Inch	D2 mm	L mm	Male End Type
80666707	3/4"	1/2"	38	70	Steel Ball
80666712	3/4"	1/2"	44	125	Steel Ball
80666715	3/4"	1/2"	44	150	Steel Ball
80666720	3/4"	1/2"	44	200	Steel Ball
80666725	3/4"	1/2"	44	250	Steel Ball
80666730	3/4"	1/2"	44	300	Steel Ball
80666740	3/4"	1/2"	44	400	Steel Ball

## 万向接头 Universal Joints

3/4" Square Drive ■ Square

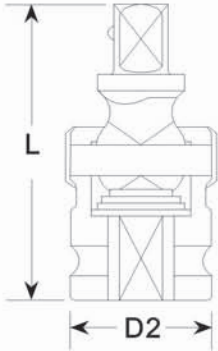

Steel Ball  
钢珠式



Lock Pin  
锁销式



Pin Hole  
销孔式



Order No.	□ Inch	■ Inch	D2 mm	L mm	Male End Type
80668530	3/4"	3/4"	44	100	Steel Ball
80668532	3/4"	3/4"	44	100	Lock Pin
80668535	3/4"	3/4"	44	100	Pin Hole

## 颤动万向头 Wobble Adapter

3/4" Square Drive ■ 3/4" Square

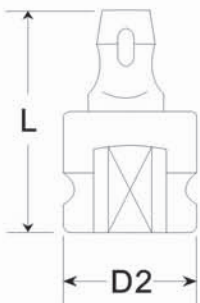

Order No.	D2 mm	L mm	Male End Type
80668590	44	73	Pin Hole



# NORMECO INDUSTRIAL SOCKETS

- 1/4" P1-10
- 3/8" P11-44
- 1/2" P45-92
- 5/8" P93-94
- 3/4" P95-112
- 1" P113-128
- 1-1/2" P129-132
- 2-1/2" P133-136
- 起子套筒 P137-145
- 起子头 P146-164

## 转换头 Adapter

  3/4" Square Drive   
  Square

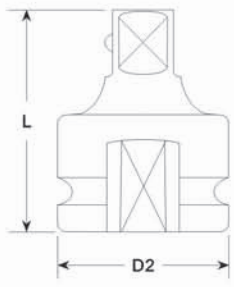

Steel Ball  
钢珠式

Lock Pin  
锁销式

Pin Hole  
销孔式



Order No.	<span style="border: 1px solid black; border-radius: 50%; padding: 2px;"> </span> Inch	<span style="display: inline-block; width: 10px; height: 10px; background-color: black; margin-right: 5px;"></span> Inch	D2 mm	L mm	Male End Type
80665510	3/4"	1/2"	44	56	Steel Ball
80665515	3/4"	1/2"	44	75	Steel Ball
80665520	3/4"	1/2"	44	100	Steel Ball
80665525	3/4"	1/2"	44	125	Steel Ball
80665530	3/4"	1/2"	44	150	Steel Ball
80665535	3/4"	1/2"	44	200	Steel Ball
80665540	3/4"	1/2"	44	250	Steel Ball
80665545	3/4"	1/2"	44	300	Steel Ball

Order No.	<span style="border: 1px solid black; border-radius: 50%; padding: 2px;"> </span> Inch	<span style="display: inline-block; width: 10px; height: 10px; background-color: black; margin-right: 5px;"></span> Inch	D2 mm	L mm	Male End Type
80665550	3/4"	1/2"	44	56	Lock Pin
80665555	3/4"	1/2"	44	75	Lock Pin
80665560	3/4"	1/2"	44	100	Lock Pin
80665565	3/4"	1/2"	44	125	Lock Pin
80665570	3/4"	1/2"	44	150	Lock Pin
80665575	3/4"	1/2"	44	200	Lock Pin
80665580	3/4"	1/2"	44	250	Lock Pin
80665585	3/4"	1/2"	44	300	Lock Pin

Order No.	<span style="border: 1px solid black; border-radius: 50%; padding: 2px;"> </span> Inch	<span style="display: inline-block; width: 10px; height: 10px; background-color: black; margin-right: 5px;"></span> Inch	D2 mm	L mm	Male End Type
80665590	3/4"	1/2"	44	56	Pin Hole
80665595	3/4"	1/2"	44	75	Pin Hole
80665600	3/4"	1/2"	44	100	Pin Hole
80665605	3/4"	1/2"	44	125	Pin Hole
80665610	3/4"	1/2"	44	150	Pin Hole
80665615	3/4"	1/2"	44	200	Pin Hole
80665620	3/4"	1/2"	44	250	Pin Hole
80665625	3/4"	1/2"	44	300	Pin Hole

Order No.	<span style="border: 1px solid black; border-radius: 50%; padding: 2px;"> </span> Inch	<span style="display: inline-block; width: 10px; height: 10px; background-color: black; margin-right: 5px;"></span> Inch	D2 mm	L mm	Male End Type
80665640	3/4"	1"	44	63	Steel Ball
80665645	3/4"	1"	44	100	Steel Ball
80665650	3/4"	1"	44	150	Steel Ball

Order No.	<span style="border: 1px solid black; border-radius: 50%; padding: 2px;"> </span> Inch	<span style="display: inline-block; width: 10px; height: 10px; background-color: black; margin-right: 5px;"></span> Inch	D2 mm	L mm	Male End Type
80665655	3/4"	1"	44	63	Lock Pin
80665660	3/4"	1"	44	100	Lock Pin
80665665	3/4"	1"	44	150	Lock Pin

Order No.	<span style="border: 1px solid black; border-radius: 50%; padding: 2px;"> </span> Inch	<span style="display: inline-block; width: 10px; height: 10px; background-color: black; margin-right: 5px;"></span> Inch	D2 mm	L mm	Male End Type
80665670	3/4"	1"	44	63	Pin Hole
80665675	3/4"	1"	44	100	Pin Hole
80665680	3/4"	1"	44	150	Pin Hole

# NORMECO INDUSTRIAL SOCKETS



## NORMECO套筒应用

## Special parts Application



1/4"

P1-10



3/8"

P11-44



1/2"

P45-92



5/8"

P93-94



3/4"

P95-112



1"

P113-128



1-1/2"

P129-132



2-1/2"

P133-136



起子套筒

P137-145



起子头

P146-164



# NORMECO INDUSTRIAL SOCKETS

- 1/4"
- P1-10
- 3/8"
- P11-44
- 1/2"
- P45-92
- 5/8"
- P93-94
- 3/4"
- P95-112
- 1"
- P113-128
- 1-1/2"
- P129-132
- 2-1/2"
- P133-136
- 起子套筒
- P137-145
- 起子头
- P146-164

## 六角标准套筒 6-Point Sockets

1" Square Drive      6-Point Sockets

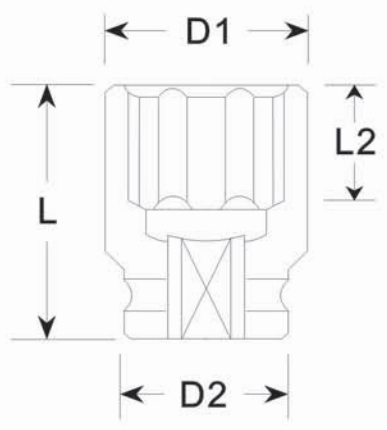

Order No.	Size Inch	D2 mm	D1 mm	L2 mm	L mm
80151510	5/8"	51	32	11	58
80151511	11/16"	51	34	12	58
80151512	3/4"	51	36	13	58
80151513	13/16"	51	38	15	58
80151514	7/8"	51	39	15	58
80151515	15/16"	51	40	18	58
80151516	1"	54	42	18	58
80151517	1-1/16"	54	44	19	58
80151518	1-1/8"	54	46	19	58
80151519	1-3/16"	54	48	21	60
80151520	1-1/4"	54	51	22	60
80151521	1-5/16"	54	53	22	62
80151522	1-3/8"	54	54	22	62
80151523	1-7/16"	54	56	25	62
80151524	1-1/2"	54	58	25	62
80151525	1-9/16"	54	60	25	62
80151526	1-5/8"	54	61.5	27	62
80151527	1-11/16"	54	65	27	64
80151528	1-3/4"	58	66	27	64
80151529	1-13/16"	58	68	30	64
80151530	1-7/8"	58	70	32	66
80151531	1-15/16"	58	72	32	68
80151532	2"	58	74	35	70
80151533	2-1/16"	58	75	35	70
80151534	2-1/8"	58	78	35	70
80151535	2-3/16"	62	80	35	72
80151536	2-1/4"	62	84	40	75
80151537	2-5/16"	62	86	40	75
80151538	2-3/8"	62	87	42	78
80151539	2-7/16"	62	89	42	78
80151540	2-1/2"	62	91	42	80
80151541	2-9/16"	62	93	42	80
80151542	2-5/8"	62	95	42	82
80151543	2-11/16"	62	97	42	82
80151544	2-3/4"	62	100	42	96
80151545	2-13/16"	62	102	45	96
80151546	2-7/8"	86	104	45	96
80151547	2-15/16"	86	105	45	98
80151548	3"	86	107	48	100
80151549	3-1/8"	86	111	48	100

# NORMECO INDUSTRIAL SOCKETS



## 六角标准套筒 6-Point Sockets



1" Square Drive



6-Point Sockets

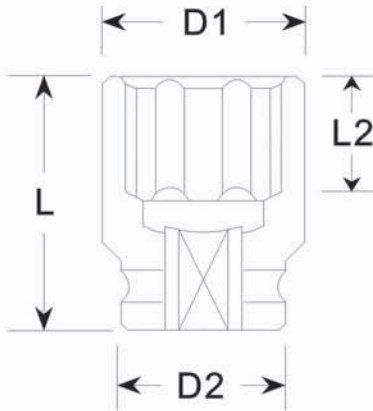

Order No.	Size mm	D2 mm	D1 mm	L2 mm	L mm
80151016	16	51	32	12	58
80151017	17	51	34	13	58
80151018	18	51	35	13	58
80151019	19	51	36	13	58
80151020	20	51	37	14	58
80151021	21	51	38	15	58
80151022	22	51	39	15	58
80151023	23	51	40	16	58
80151024	24	54	41	18	58
80151025	25	54	42	18	58
80151026	26	54	43	18	58
80151027	27	54	44	19	58
80151028	28	54	45	19	58
80151029	29	54	46	19	58
80151030	30	54	48	21	60
80151031	31	54	51	21	62
80151032	32	54	52	22	62
80151033	33	54	53	22	62
80151034	34	54	55	22	62
80151035	35	54	56	22	65
80151036	36	54	57	25	67
80151037	37	54	59	25	67
80151038	38	54	60	25	67
80151041	41	54	63	27	70
80151042	42	54	65	27	74
80151046	46	54	70	30	76
80151048	48	54	72.5	32	76
80151050	50	62	75	35	80
80151055	55	62	81	35	84
80151060	60	62	87	42	87
80151065	65	62	93	42	90
80151070	70	62	100	42	96
80151075	75	86	106	45	98
80151080	80	86	112	48	100
80151085	85	86	118	52	105
80151090	90	86	125	52	105
80151095	95	86	131	52	115
80151100	100	95	137	58	115
80151105	105	95	143	58	115
80151110	110	95	149	60	115



1/4"

P1-10



3/8"

P11-44



1/2"

P45-92



5/8"

P93-94



3/4"

P95-112



1"

P113-128



1-1/2"

P129-132



2-1/2"

P133-136



起子套筒

P137-145

起子头

P146-164



# NORMECO INDUSTRIAL SOCKETS

1/4"
P1-10
3/8"
P11-44
1/2"
P45-92
5/8"
P93-94
3/4"
P95-112
<b>1"</b>
P113-128
1-1/2"
P129-132
2-1/2"
P133-136
起子套筒
P137-145
起子头
P146-164

## 六角加长套筒 6-Point Sockets-Deep Length

1" Square Drive 6-Point

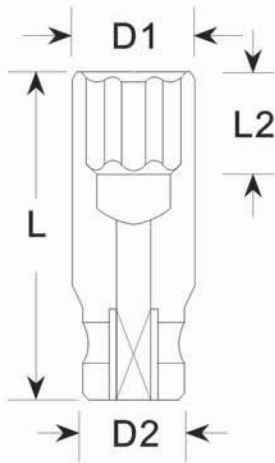

Order No.	Size Inch	D2 mm	D1 mm	L2 mm	L mm
80153510	5/8"	54	32	16	90
80153511	11/16"	54	34	17	90
80153512	3/4"	54	36	19	90
80153513	13/16"	54	38	22	90
80153514	7/8"	54	39	22	90
80153515	15/16"	54	40	24	90
80153516	1"	54	42	25	90
80153517	1-1/16"	54	44	27	90
80153518	1-1/8"	54	46	29	90
80153519	1-3/16"	54	48	30	90
80153520	1-1/4"	54	51	32	90
80153521	1-5/16"	54	53	34	90
80153522	1-3/8"	54	54	35	90
80153523	1-7/16"	54	56	37	90
80153524	1-1/2"	54	58	38	92
80153525	1-9/16"	54	60	38	92
80153526	1-5/8"	54	61.5	38	92
80153527	1-11/16"	54	65	38	92
80153528	1-3/4"	58	66	38	92
80153529	1-13/16"	58	68	38	92
80153530	1-7/8"	58	70	38	92
80153531	1-15/16"	58	72	38	92
80153532	2"	58	74	40	95
80153533	2-1/16"	58	75	40	95
80153534	2-1/8"	58	78	40	100
80153535	2-3/16"	62	80	40	100
80153536	2-1/4"	62	84	40	100
80153537	2-5/16"	62	86	40	105
80153538	2-3/8"	62	87	42	105
80153539	2-7/16"	62	89	42	110
80153540	2-1/2"	62	91	42	110
80153541	2-9/16"	62	93	42	125
80153542	2-5/8"	62	95	42	125
80153543	2-11/16"	62	97	42	125
80153544	2-3/4"	62	100	42	125
80153545	2-13/16"	62	102	45	125
80153546	2-7/8"	86	104	45	125
80153547	2-15/16"	86	105	45	135
80153548	3"	86	107	48	135
80153549	3-1/8"	86	111	48	135

# NORMECO INDUSTRIAL SOCKETS



## 六角加长套筒 6-Point Sockets-Deep Length



1" Square Drive



6-Point

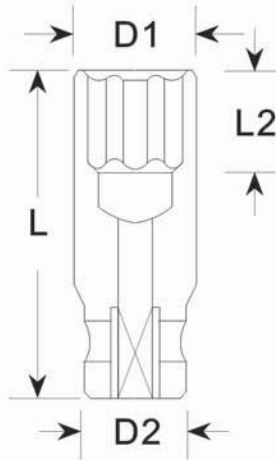

Order No.	Size mm	D2 mm	D1 mm	L2 mm	L mm
80153016	16	54	32	16	100
80153017	17	54	34	17	100
80153018	18	54	35	18	100
80153019	19	54	36	19	100
80153020	20	54	37	20	100
80153021	21	54	38	21	100
80153022	22	54	40	22	100
80153023	23	54	41	23	100
80153024	24	54	42	24	100
80153025	25	54	43	25	100
80153026	26	54	44.5	26	100
80153027	27	54	46	27	100
80153028	28	54	47	28	100
80153029	29	54	48	29	100
80153030	30	54	50	30	100
80153031	31	54	51	31	100
80153032	32	54	52	32	100
80153033	33	54	53	33	100
80153034	34	54	55	34	100
80153035	35	54	56	35	100
80153036	36	54	57	36	100
80153037	37	54	59	37	100
80153038	38	54	60	38	100
80153041	41	54	63	38	100
80153042	42	54	65	38	100
80153046	46	54	70	38	100
80153048	48	54	72.5	38	100
80153050	50	62	75	38	100
80153055	55	62	81	40	100
80153060	60	62	87	42	120
80153065	65	62	93	42	125
80153070	70	62	100	42	125
80153075	75	86	106	45	135
80153080	80	86	112	48	135
80153085	85	86	118	52	140
80153090	90	86	125	52	140
80153095	95	86	131	52	140
80153100	100	95	137	58	140
80153105	105	95	143	58	155
80153110	110	95	149	60	155



1/4"

P1-10



3/8"

P11-44



1/2"

P45-92



5/8"

P93-94



3/4"

P95-112



1"

P113-128



1-1/2"

P129-132



2-1/2"

P133-136



起子套筒

P137-145

起子头

P146-164



# NORMECO INDUSTRIAL SOCKETS

- 1/4" P1-10
- 3/8" P11-44
- 1/2" P45-92
- 5/8" P93-94
- 3/4" P95-112
- 1" P113-128
- 1-1/2" P129-132
- 2-1/2" P133-136
- 起子套筒 P137-145
- 起子头 P146-164

## 六角套筒 6-Point Sockets

1" Square Drive 6-Point

● 维修级 Maintenance Purpose

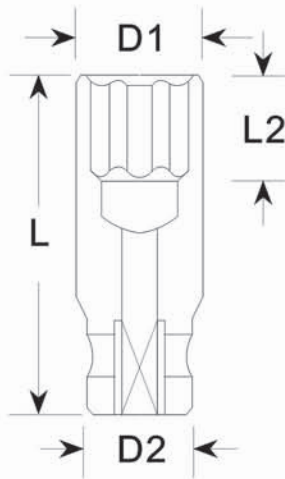

Order No.	Size mm	D2 mm	D1 mm	L2 mm	L mm
80155021	21	51	38	25	88
80155022	22	51	39	25	88
80155024	24	51	42	25	88
80155027	27	51	45	28	88
80155029	29	51	48	28	88
80155030	30	54	50	30	88
80155032	32	54	52	32	88
80155033	33	54	53	32	88
80155034	34	54	54	33	88
80155035	35	54	55	34	88
80155036	36	54	56	40	88
80155038	38	54	59	40	88
80155041	41	54	63	40	88
80155046	46	54	69	50	100
80155050	50	54	74	50	100
80155055	55	56	80	60	110
80155060	60	60	87	60	110
80155065	65	65	93	65	120
80155070	70	70	99	65	125
80155075	75	75	105	65	125
80155080	80	86	109	75	135
80155085	85	86	115	75	140



● 维修级 Maintenance Purpose

维修级产品适用于维修、家居及工作室等较低使用频次及使用强度的场所。Maintenance-grade products are suitable for working situation with low frequency and intensity of use, such as maintenance, DIY and studio.

# NORMECO INDUSTRIAL SOCKETS



## 十二角标准套筒 12-Point Sockets



1" Square Drive



12-Point

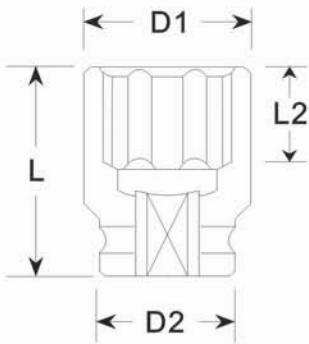

Order No.	Size mm	D2 mm	D1 mm	L2 mm	L mm
80251016	16	51	32	11	60
80251017	17	51	34	12	60
80251018	18	51	35	13	60
80251019	19	54	36	13	60
80251020	20	54	37	14	60
80251021	21	54	38	15	60
80251022	22	54	40	15	60
80251023	23	54	41	16	60
80251024	24	54	42	18	60
80251025	25	54	43	18	60
80251026	26	54	44.5	18	60
80251027	27	54	46	19	62
80251028	28	54	47	19	62
80251029	29	54	48	19	62
80251030	30	54	50	21	62
80251031	31	54	51	21	62
80251032	32	54	52	22	62
80251033	33	54	53	22	62
80251034	34	54	55	22	62
80251035	35	54	56	22	65
80251036	36	54	57	25	67
80251037	37	54	59	25	67
80251038	38	54	60	25	67
80251041	41	54	63	27	70
80251046	46	58	70	30	76
80251050	50	62	75	35	80
80251055	55	62	81	35	84
80251060	60	62	87	42	87
80251065	65	62	93	42	90
80251070	70	62	100	42	96
80251075	75	86	106	45	98
80251080	80	86	112	48	100
80251085	85	86	118	52	105
80251090	90	86	125	52	105
80251095	95	86	131	52	115
80251100	100	86	137	58	115
80251105	105	95	143	58	115
80251110	110	95	149	60	115
80251115	115	95	155	62	115



1/4"
P1-10
3/8"
P11-44
1/2"
P45-92
5/8"
P93-94
3/4"
P95-112
1"
P113-128
1-1/2"
P129-132
2-1/2"
P133-136
起子套筒
P137-145
起子头
P146-164



# NORMECO INDUSTRIAL SOCKETS

- 1/4" P1-10
- 3/8" P11-44
- 1/2" P45-92
- 5/8" P93-94
- 3/4" P95-112
- 1" P113-128
- 1-1/2" P129-132
- 2-1/2" P133-136
- 起子套筒 P137-145
- 起子头 P146-164

## 十二角加长套筒 12-Point Sockets-Deep length

1" Square Drive
 12-Point

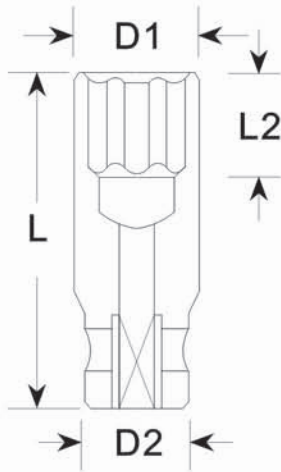



Order No.	Size mm	D2 mm	D1 mm	L2 mm	L mm
80253016	16	54	32	16	100
80253017	17	54	34	17	100
80253018	18	54	35	18	100
80253019	19	54	36	19	100
80253020	20	54	37	20	100
80253021	21	54	38	21	100
80253022	22	54	40	22	100
80253023	23	54	41	23	100
80253024	24	54	42	24	100
80253025	25	54	43	25	100
80253026	26	54	44.5	26	100
80253027	27	54	46	27	100
80253028	28	54	47	28	100
80253029	29	54	48	29	100
80253030	30	54	50	30	100
80253031	31	54	51	31	100
80253032	32	54	52	32	100
80253033	33	54	53	33	100
80253034	34	54	55	34	100
80253035	35	54	56	35	100
80253036	36	54	57	36	100
80253037	37	54	59	37	100
80253038	38	54	60	38	100
80253041	41	54	63	38	100
80253046	46	58	70	38	100
80253050	50	62	75	38	100
80253055	55	62	81	40	100
80253060	60	62	87	42	120
80253065	65	62	93	42	125
80253070	70	62	100	42	125
80253075	75	86	106	45	135
80253080	80	86	112	48	135
80253085	85	86	118	52	140
80253090	90	86	125	52	140
80253095	95	86	131	52	140
80253100	100	86	137	58	140
80253105	105	95	143	58	155
80253110	110	95	149	60	155
80253115	115	95	155	62	155





## ▶ 六角大圆弧标准套筒 Surface Drive 6-Point Sockets



 1 " Square Drive
  Surface Drive

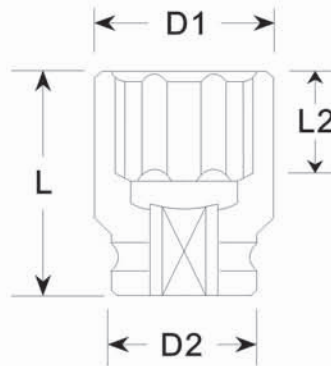

Order No.	Size mm	D2 mm	D1 mm	L2 mm	L mm
80465821	21	54	38	15	58
80465822	22	54	39	15	58
80465823	23	54	40	16	58
80465824	24	54	40	18	58
80465825	25	54	41	18	58
80465826	26	54	42.5	18	58
80465827	27	54	44	19	58
80465828	28	54	45	19	58
80465829	29	54	46	19	58
80465830	30	54	48	21	60
80465831	31	54	51	21	62
80465832	32	54	52	22	62
80465834	34	54	55	22	62
80465836	36	54	57	25	67



## ▶ 六角大圆弧加长套筒 Surface Drive 6-Point Sockets-Deep Length

 1 " Square Drive
  Surface Drive

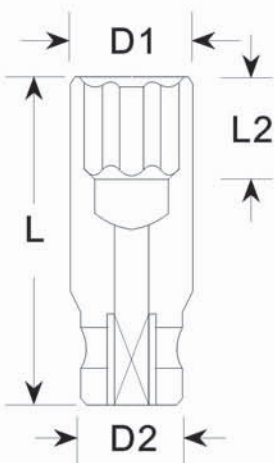

Order No.	Size mm	D2 mm	D1 mm	L2 mm	L mm
80465921	21	54	38	21	100
80465922	22	54	40	22	100
80465923	23	54	41	23	100
80465924	24	54	42	24	100
80465925	25	54	43	25	100
80465926	26	54	44.5	26	100
80465927	27	54	46	27	100
80465928	28	54	47	28	100
80465929	29	54	48	29	100
80465930	30	54	50	30	100
80465931	31	54	51	31	100
80465932	32	54	52	32	100
80465934	34	54	55	34	100
80465936	36	54	57	36	100



1 / 4"

P11-10



3 / 8"

P11-44



1 / 2"

P45-92



5 / 8"

P93-94



3 / 4"

P95-112



1"

P113-128



1-1 / 2"

P129-132



2-1 / 2"

P133-136



起子套筒

P137-145

起子头

P146-164



# NORMECO INDUSTRIAL SOCKETS

- 1/4"
- P1-10
- 3/8"
- P11-44
- 1/2"
- P45-92
- 5/8"
- P93-94
- 3/4"
- P95-112
- 1"
- P113-128
- 1-1/2"
- P129-132
- 2-1/2"
- P133-136
- 起子套筒
- P137-145
- 起子头
- P146-164

## 外星型标准套筒 External Torx

1" Square Drive External Torx

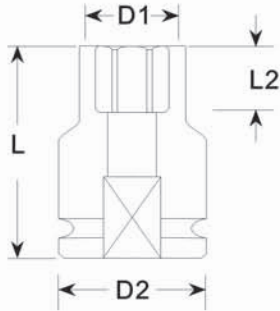

Order No.	Size	D2 mm	D1 mm	L2 mm	L mm
80176616	E16	54	25	13	65
80176618	E18	54	28	15	65
80176620	E20	54	30	15	65
80176622	E22	54	33	19	65
80176624	E24	54	36	19	65



## 外星型加长套筒 External Torx Sockets-Deep Length

1" Square Drive External Torx

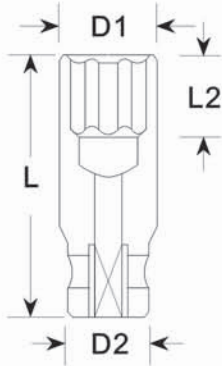

Order No.	Size	D2 mm	D1 mm	L2 mm	L mm
80176816	E16	54	25	13	110
80176818	E18	54	28	15	110
80176820	E20	54	30	15	110
80176822	E22	54	33	19	110
80176824	E24	54	36	19	110



## 四方套筒 4-Point Female Sockets

1" Square Drive Square

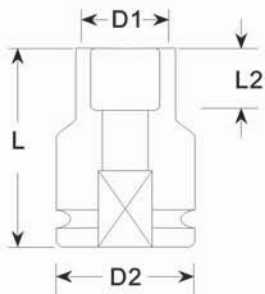

Order No.	Size mm	D2 mm	D1 mm	L2 mm	L mm
80178722	22	52	44	24	57
80178724	24	54	50	18	60

Order No.	Size mm	D2 mm	D1 mm	L2 mm	L mm
80178812	3/4"	52	43	13	57
80178813	13/16"	52	44	15	57
80178814	7/8"	54	48	15	60
80178815	15/16"	54	50	18	60
80178816	1"	54	53	18	60
80178818	1-1/8"	54	60	19	60
80178826	1-1/2"	54	75	24	75



# NORMECO INDUSTRIAL SOCKETS



## 八角标准套筒 8-Point Sockets-Double Square

 1" Square Drive
  Double Square

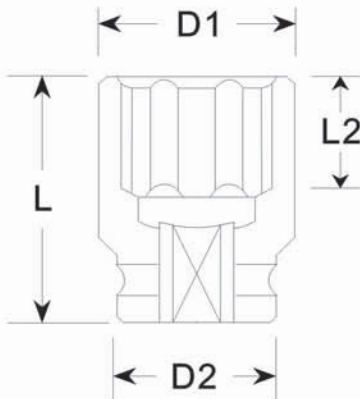

Order No.	Size mm	D2 mm	D1 mm	L2 mm	L mm
80466L19	19	54	45	13	60
80466L20	20	54	46.5	13	60
80466L21	21	54	48	15	60
80466L22	22	54	49.5	15	60
80466L23	23	54	50.5	15	60
80466L24	24	54	52	18	60
80466L25	25	54	54	18	60
80466L26	26	54	55	18	60
80466L27	27	54	56.5	19	60
80466L28	28	54	58	19	62
80466L29	29	54	59.5	19	62
80466L30	30	54	61	21	62
80466L31	31	54	62	21	62
80466L32	32	54	64	22	62
80466L33	33	54	66	22	62
80466L34	34	54	67	22	62
80466L35	35	58	68.5	22	65
80466L36	36	58	70	24	67
80466L37	37	58	72	24	67
80466L38	38	58	73	24	67
80466L39	39	58	74	24	70
80466L40	40	58	76	24	70
80466L42	42	58	80	27	74
80466L46	46	62	86	30	76
80466L50	50	62	93	32	80
80466L55	55	62	100	35	84

Order No.	Size inch	D2 mm	D1 mm	L2 mm	L mm
80466J24	3/4 "	54	45	13	60
80466J26	13/16 "	54	47	15	60
80466J28	7/8 "	54	50	15	60
80466J30	15/16 "	54	52	18	60
80466J32	1 "	54	54	18	60
80466J34	1-1/16 "	54	56	19	60
80466J36	1-1/8 "	54	59	19	62
80466J38	1-3/16 "	54	61	21	62
80466J40	1-1/4 "	54	63	22	62
80466J42	1-5/16 "	54	66	22	62
80466J44	1-3/8 "	58	68	22	65
80466J46	1-7/16 "	58	71	24	67
80466J48	1-1/2 "	58	73	24	67
80466J50	1-9/16 "	58	75	24	70
80466J52	1-5/8 "	58	78	27	70
80466J54	1-11/16 "	62	82	27	74
80466J56	1-3/4 "	62	84	27	74
80466J58	1-13/16 "	62	86	30	76
80466J60	1-7/8 "	62	88	30	76
80466J62	1-15/16 "	62	92	30	80
80466J64	2 "	62	94	32	80
80466J66	2-1/16 "	62	96	32	84
80466J68	2-1/8 "	62	98	32	84
80466J70	2-3/16 "	62	101	35	84
80466J72	2-1/4 "	62	103	35	84

	1/4 "
P1-10	
	3/8 "
P11-44	
	1/2 "
P45-92	
	5/8 "
P93-94	
	3/4 "
P95-112	
	1 "
P113-128	
	1-1/2 "
P129-132	
	2-1/2 "
P133-136	
	起子套筒
P137-145	
	起子头
P146-164	



# NORMECO INDUSTRIAL SOCKETS

- 1/4"
- P1-10
- 3/8"
- P11-44
- 1/2"
- P45-92
- 5/8"
- P93-94
- 3/4"
- P95-112
- 1"
- P113-128
- 1-1/2"
- P129-132
- 2-1/2"
- P133-136
- 起子套筒
- P137-145
- 起子头
- P146-164

## 八角加长套筒 Double Square Sockets-Deep Length

1" Square Drive
  Double Square

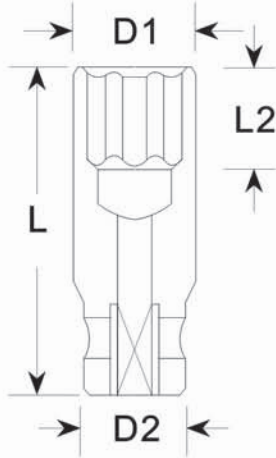

Order No.	Size mm	D2 mm	D1 mm	L2 mm	L mm
80466P19	19	54	45	13	100
80466P20	20	54	46.5	13	100
80466P21	21	54	48	15	100
80466P22	22	54	49.5	15	100
80466P23	23	54	50.5	15	100
80466P24	24	54	52	18	100
80466P25	25	54	54	18	100
80466P26	26	54	55	18	100
80466P27	27	54	56.5	19	100
80466P28	28	54	58	19	100
80466P29	29	54	59.5	19	100
80466P30	30	54	61	21	100
80466P31	31	54	62	21	100
80466P32	32	54	64	22	100
80466P33	33	54	66	22	100
80466P34	34	54	67	22	100
80466P35	35	58	68.5	22	100
80466P36	36	58	70	24	100
80466P37	37	58	72	24	100
80466P38	38	58	73	24	100
80466P39	39	58	74	24	100
80466P40	40	58	76	24	105
80466P42	42	58	80	27	105
80466P46	46	62	86	30	105
80466P50	50	62	93	32	105
80466P55	55	62	100	35	105

Order No.	Size inch	D2 mm	D1 mm	L2 mm	L mm
80466N24	3/4"	54	45	13	100
80466N26	13/16"	54	47	15	100
80466N28	7/8"	54	50	15	100
80466N30	15/16"	54	52	18	100
80466N32	1"	54	54	18	100
80466N34	1-1/16"	54	56	19	100
80466N36	1-1/8"	54	59	19	100
80466N38	1-3/16"	54	61	21	100
80466N40	1-1/4"	54	63	22	100
80466N42	1-5/16"	54	66	22	100
80466N44	1-3/8"	58	68	22	100
80466N46	1-7/16"	58	71	24	100
80466N48	1-1/2"	58	73	24	100
80466N50	1-9/16"	58	75	24	100
80466N52	1-5/8"	58	78	27	100
80466N54	1-11/16"	62	82	27	100
80466N56	1-3/4"	62	84	27	100
80466N58	1-13/16"	62	86	30	100
80466N60	1-7/8"	62	88	30	105
80466N62	1-15/16"	62	92	30	105
80466N64	2"	62	94	32	105
80466N66	2-1/16"	62	96	32	105
80466N68	2-1/8"	62	98	32	105
80466N70	2-3/16"	62	101	35	105
80466N72	2-1/4"	62	103	35	105

# NORMECO INDUSTRIAL SOCKETS



## 内六角套筒 Male Hex Drive Sockets

 1" Square Drive
  Hex

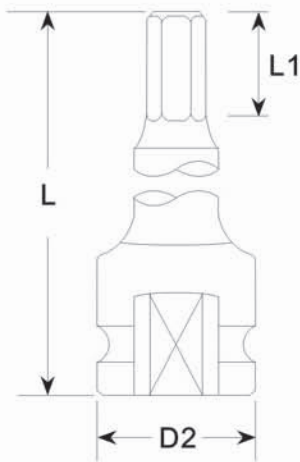

Order No.	● Size mm	D2 mm	L1 mm	L mm
80570010	10	54	20	75
80570012	12	54	20	75
80570014	14	54	20	75
80570017	17	54	20	75
80570019	19	54	20	75
80570022	22	54	20	75
80570024	24	54	20	75
80570027	27	54	20	75
80570028	28	54	20	75
80570030	30	54	20	75
80570032	32	54	20	75
80570033	33	54	20	75
80570036	36	54	20	75
80570038	38	54	20	75
80570041	41	54	20	75
80570046	46	54	20	75

Order No.	● Size inch	D2 mm	L1 mm	L mm
80572016	1/2"	54	20	75
80572018	9/16"	54	20	75
80572020	5/8"	54	20	75
80572024	3/4"	54	20	75
80572026	13/16"	54	20	75
80572028	7/8"	54	20	75
80572100	1"	54	20	75
80572102	1-1/16"	54	20	75
80572104	1-1/8"	54	20	75
80572106	1-3/16"	54	20	75
80572108	1-1/4"	54	20	75
80572110	1-5/16"	54	20	75
80572112	1-3/8"	54	20	75
80572116	1-1/2"	54	20	75
80572120	1-5/8"	54	20	75
80572124	1-3/4"	54	20	75



 1/4"

P1-10

 3/8"

P11-44

 1/2"

P45-92

 5/8"

P93-94

 3/4"

P95-112

 1"

P113-128

 1-1/2"

P129-132

 2-1/2"

P133-136

 起子套筒

P137-145

起子头

P146-164



# NORMECO INDUSTRIAL SOCKETS

1/4"
P1-10
3/8"
P11-44
1/2"
P45-92
5/8"
P93-94
3/4"
P95-112
1"
P113-128
1-1/2"
P129-132
2-1/2"
P133-136
起子套筒
P137-145
起子头
P146-164

## 内六角套筒 Male Hex Drive Sockets

1" Square Drive      Hex Drive

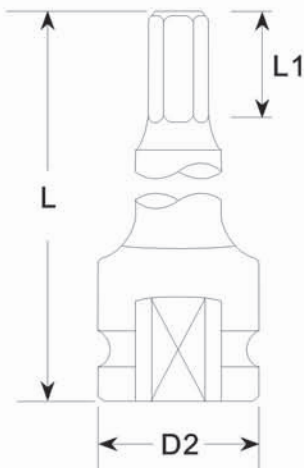

Order No.	Size mm	D2 mm	L1 mm	L mm
80576010	10	54	20	100
80576012	12	54	20	100
80576014	14	54	20	100
80576017	17	54	20	100
80576019	19	54	20	100
80576022	22	54	20	100
80576024	24	54	20	100
80576027	27	54	20	100
80576028	28	54	20	100
80576030	30	54	20	100
80576032	32	54	20	100
80576033	33	54	20	100
80576036	36	54	28	100
80576038	38	54	28	100
80576041	41	54	28	100
80576046	46	62	28	100
80576055	55	62	28	100
80576065	65	62	28	100

Order No.	Size inch	D2 mm	L1 mm	L mm
80578016	1/2"	54	20	100
80578018	9/16"	54	20	100
80578020	5/8"	54	20	100
80578024	3/4"	54	20	100
80578026	13/16"	54	20	100
80578028	7/8"	54	20	100
80578100	1"	54	20	100
80578102	1-1/16"	54	20	100
80578104	1-1/8"	54	20	100
80578106	1-3/16"	54	20	100
80578108	1-1/4"	54	20	100
80578110	1-5/16"	54	20	100
80578112	1-3/8"	54	20	100
80578116	1-1/2"	54	20	100
80578120	1-5/8"	54	20	100
80578124	1-3/4"	54	20	100



## ▶ 延长杆 Extension Bars

1" Square Drive ■ Square

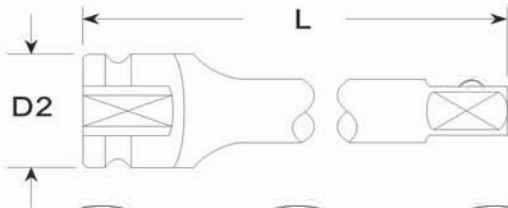

Steel Ball  
钢珠式

Lock Pin  
锁销式

Pin Hole  
销孔式



Order No.	1" Inch	1" Inch	D2 mm	L mm	Male End Type
80636100	1"	1"	54	100	Steel Ball
80636125	1"	1"	54	125	Steel Ball
80636150	1"	1"	54	150	Steel Ball
80636200	1"	1"	54	200	Steel Ball
80636250	1"	1"	54	250	Steel Ball
80636300	1"	1"	54	300	Steel Ball
80636400	1"	1"	54	400	Steel Ball
80636500	1"	1"	54	500	Steel Ball
80636600	1"	1"	54	600	Steel Ball
80636800	1"	1"	54	800	Steel Ball

Order No.	1" Inch	1" Inch	D2 mm	L mm	Male End Type
80637100	1"	1"	54	100	Lock Pin
80637150	1"	1"	54	150	Lock Pin
80637200	1"	1"	54	200	Lock Pin
80637250	1"	1"	54	250	Lock Pin
80637300	1"	1"	54	300	Lock Pin
80637400	1"	1"	54	400	Lock Pin
80637500	1"	1"	54	500	Lock Pin
80637600	1"	1"	54	600	Lock Pin
80637800	1"	1"	54	800	Lock Pin

Order No.	1" Inch	1" Inch	D2 mm	L mm	Male End Type
80638100	1"	1"	54	100	Pin Hole
80638150	1"	1"	54	150	Pin Hole
80638200	1"	1"	54	200	Pin Hole
80638250	1"	1"	54	250	Pin Hole
80638300	1"	1"	54	300	Pin Hole
80638400	1"	1"	54	400	Pin Hole
80638500	1"	1"	54	500	Pin Hole
80638600	1"	1"	54	600	Pin Hole
80638800	1"	1"	54	800	Pin Hole

## ▶ 快换式延长杆 Quick-Change Extension Bars

1" Square Drive ■ Square

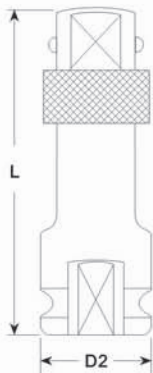

Order No.	1" Inch	1" Inch	D2 mm	L mm	Male End Type
80638C10	1"	1"	54	100	Steel Ball
80638C15	1"	1"	54	150	Steel Ball
80638C20	1"	1"	54	200	Steel Ball
80638C25	1"	1"	54	250	Steel Ball
80638C30	1"	1"	54	300	Steel Ball
80638C40	1"	1"	54	400	Steel Ball



# NORMECO INDUSTRIAL SOCKETS

- 1/4"
- P1-10
- 3/8"
- P11-44
- 1/2"
- P45-92
- 5/8"
- P93-94
- 3/4"
- P95-112
- 1"
- P113-128
- 1-1/2"
- P129-132
- 2-1/2"
- P133-136
- 起子套筒
- P137-145
- 起子头
- P146-164

## 转换头 Adapter

1" Square Drive    Square

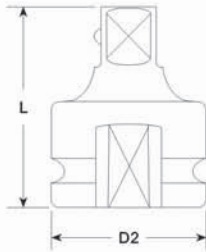

Steel Ball  
钢珠式

Lock Pin  
锁销式

Pin Hole  
销孔式



Order No.	1" Inch	3/4" Inch	D2 mm	L mm	Male End Type
80665710	1"	3/4"	54	75	Steel Ball
80665715	1"	3/4"	54	100	Steel Ball
80665720	1"	3/4"	54	125	Steel Ball
80665725	1"	3/4"	54	150	Steel Ball
80665730	1"	3/4"	54	200	Steel Ball
80665735	1"	3/4"	54	250	Steel Ball
80665740	1"	3/4"	54	300	Steel Ball
80665745	1"	3/4"	54	400	Steel Ball

Order No.	1" Inch	3/4" Inch	D2 mm	L mm	Male End Type
80665750	1"	3/4"	54	75	Lock Pin
80665755	1"	3/4"	54	100	Lock Pin
80665760	1"	3/4"	54	125	Lock Pin
80665765	1"	3/4"	54	150	Lock Pin
80665770	1"	3/4"	54	200	Lock Pin
80665775	1"	3/4"	54	250	Lock Pin
80665780	1"	3/4"	54	300	Lock Pin
80665785	1"	3/4"	54	400	Lock Pin

Order No.	1" Inch	3/4" Inch	D2 mm	L mm	Male End Type
80665788	1"	3/4"	54	75	Pin Hole
80665790	1"	3/4"	54	100	Pin Hole
80665792	1"	3/4"	54	125	Pin Hole
80665794	1"	3/4"	54	150	Pin Hole
80665796	1"	3/4"	54	200	Pin Hole
80665798	1"	3/4"	54	250	Pin Hole
80665800	1"	3/4"	54	300	Pin Hole
80665802	1"	3/4"	54	400	Pin Hole
80665804	1"	1-1/2"	54	90	Pin Hole

## 万向接头 Universal Joints

1" Square Drive    Square

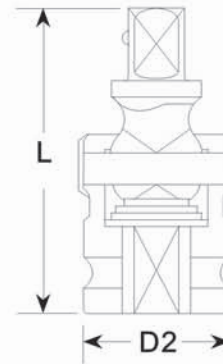

Order No.	1" Inch	1" Inch	D2 mm	L mm	Male End Type
80668540	1"	1"	54	115	Steel Ball
80668545	1"	1"	54	115	Pin Hole



▶ NORMECO套筒应用

Special Parts Applications



1/4"

P11-10



3/8"

P11-44



1/2"

P45-92



5/8"

P93-94



3/4"

P95-112



1"

P113-128



1-1/2"

P129-132



2-1/2"

P133-136



起子套筒

P137-145

起子头

P146-164



# NORMECO INDUSTRIAL SOCKETS

1/4"
P1-10
3/8"
P11-44
1/2"
P45-92
5/8"
P93-94
3/4"
P95-112
1"
P113-128
1-1/2"
P129-132
2-1/2"
P133-136
起子套筒
P137-145
起子头
P146-164

## 六角标准套筒 6-Point Sockets

 1-1/2" Square Drive
  6-Point Sockets

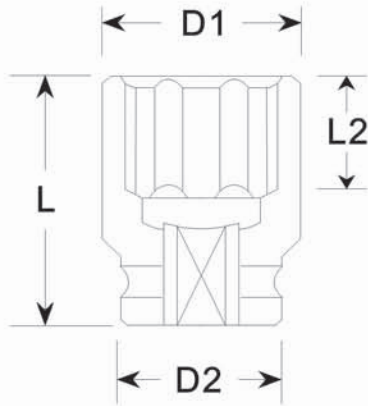

Order No.	Size mm	D2 mm	D1 mm	L2 mm	L mm
80158030	30	86	56	21	78
80158032	32	86	58	22	78
80158034	34	86	61	22	78
80158036	36	86	64	24	78
80158038	38	86	66	26	80
80158040	40	86	68	28	80
80158041	41	86	70	28	80
80158042	42	86	71	28	82
80158045	45	86	75	30	84
80158046	46	86	76	30	84
80158047	47	86	77	32	87
80158048	48	86	79	32	87
80158050	50	86	81	32	87
80158052	52	86	83	34	87
80158054	54	86	86	37	90
80158055	55	86	87	37	90
80158056	56	86	88	37	92
80158058	58	86	92	39	95
80158060	60	86	94	39	95
80158061	61	86	95	42	100
80158062	62	86	96	42	100
80158063	63	86	97	42	100
80158065	65	86	100	42	100
80158068	68	86	104	46	105
80158070	70	86	106	46	105
80158072	72	86	108	49	108
80158075	75	86	112	49	108
80158078	78	86	115	53	115
80158080	80	86	119	53	115
80158085	85	86	125	56	118
80158088	88	86	128	56	118
80158090	90	86	131	59	123
80158095	95	95	137	61	123
80158100	100	95	144	65	130
80158105	105	95	154	68	130
80158110	110	95	157	72	135
80158115	115	95	164	77	140
80158120	120	95	170	77	140
80158125	125	127	174	77	140
80158130	130	127	184	80	145
80158135	135	127	194	85	150
80158140	140	127	197	90	160
80158145	145	127	204	90	160
80158150	150	127	207	90	165
80158155	155	127	214	90	165
80158160	160	127	224	90	170
80158165	165	127	227	95	175
80158170	170	127	234	95	180
80158175	175	127	244	100	185
80158185	185	127	254	100	190

# NORMECO INDUSTRIAL SOCKETS



## 六角加长套筒 6-Point Sockets-Deep Length

 1-1/2 " Square Drive
  6-Point Sockets

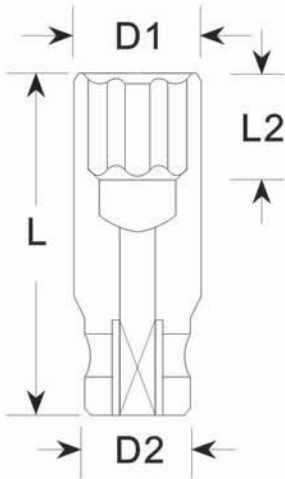

Order No.	Size mm	D2 mm	D1 mm	L2 mm	L mm
80160030	30	86	56	22	115
80160032	32	86	58	22	115
80160034	34	86	63	22	115
80160035	35	86	64	22	115
80160036	36	86	64	24	115
80160037	37	86	65	24	115
80160038	38	86	66	26	115
80160040	40	86	68	28	115
80160041	41	86	70	28	115
80160042	42	86	71	28	115
80160045	45	86	75	30	115
80160046	46	86	76	30	115
80160047	47	86	77	32	115
80160048	48	86	79	32	115
80160050	50	86	81	34	135
80160052	52	86	83	34	140
80160054	54	86	86	37	140
80160055	55	86	87	37	140
80160056	56	86	88	37	140
80160058	58	86	92	39	150
80160060	60	86	94	39	150
80160061	61	86	95	40	150
80160062	62	86	96	42	150
80160063	63	86	97	42	150
80160065	65	86	100	42	150
80160068	68	86	104	46	150
80160070	70	86	106	46	160
80160072	72	86	108	49	160
80160075	75	86	112	49	160
80160078	78	86	115	53	160
80160080	80	86	119	53	170
80160085	85	86	125	56	170
80160088	88	86	128	57	170
80160090	90	86	131	59	170
80160095	95	95	137	61	180
80160100	100	95	144	65	190
80160105	105	95	154	68	190
80160110	110	95	156	72	200
80160115	115	95	164	77	210
80160120	120	95	170	77	210
80160125	125	95	174	77	210
80160130	130	95	175	78	210



-  1/4"
-  P1-10
-  3/8"
-  P11-44
-  1/2"
-  P45-92
-  5/8"
-  P93-94
-  3/4"
-  P95-112
-  1"
-  P113-128
-  1-1/2"
-  P129-132
-  2-1/2"
-  P133-136
-  起子套筒
-  P137-145
-  起子头
-  P146-164



# NORMECO INDUSTRIAL SOCKETS

1/4"
P1-10
3/8"
P11-44
1/2"
P45-92
5/8"
P93-94
3/4"
P95-112
1"
P113-128
1-1/2"
P129-132
2-1/2"
P133-136
起子套筒
P137-145
起子头
P146-164

## 内六角套筒 Male Hex Drive Sockets

1-1/2" Square Drive Hex

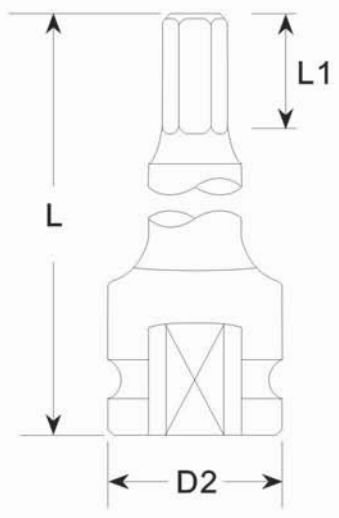

Order No.	Size mm	D2 mm	L1 mm	L mm
80579030	30	86	24	120
80579032	32	86	24	120
80579036	36	86	28	120
80579038	38	86	28	120
80579041	41	86	28	120
80579046	46	86	28	120
80579050	50	86	28	120
80579055	55	86	28	120
80579065	65	86	28	120



## 气动转换头 Adapter

1-1/2" Square Drive Square

Order No.	Inch	Inch	D2 mm	L mm	Male End Type
80665810	1-1/2"	1"	86	100	Pin Hole
80665815	1-1/2"	2-1/2"	86	120	Pin Hole

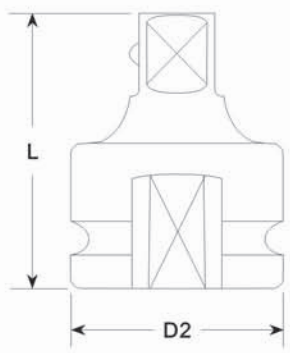

Pin Hole 销孔式





▶ 延长杆 Extension Bars

1-1/2 " Square Drive
  Square

Order No.	<span style="display: inline-block; width: 10px; height: 10px; border: 1px solid black;"></span> Inch	<span style="display: inline-block; width: 10px; height: 10px; background-color: black;"></span> Inch	D2 mm	L mm	Male End Type
80639250	1-1/2"	1-1/2"	86	250	Pin Hole
80639400	1-1/2"	1-1/2"	86	400	Pin Hole
80639500	1-1/2"	1-1/2"	86	500	Pin Hole
80639600	1-1/2"	1-1/2"	86	600	Pin Hole

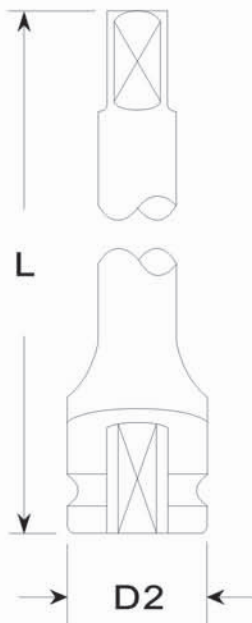

Pin Hole  
销孔式

- 1/4"
- P1-10
- 3/8"
- P11-44
- 1/2"
- P45-92
- 5/8"
- P93-94
- 3/4"
- P95-112
- 1"
- P113-128
- 1-1/2"
- P129-132
- 2-1/2"
- P133-136
- 起子套筒
- P137-145
- 起子头
- P146-164



# NORMECO INDUSTRIAL SOCKETS

- 1/4"
- P1-10
- 3/8"
- P11-44
- 1/2"
- P45-92
- 5/8"
- P93-94
- 3/4"
- P95-112
- 1"
- P113-128
- 1-1/2"
- P129-132
- 2-1/2"
- P133-136
- 起子套筒
- P137-145
- 起子头
- P146-164

## 六角标准套筒 6-Point Sockets

2-1/2" Square Drive
 6-Point Sockets

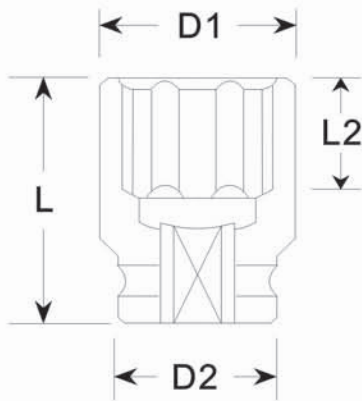

Order No.	Size mm	D2 mm	D1 mm	L2 mm	L mm
80162060	60	127	99	37	125
80162065	65	127	105	40	130
80162070	70	127	110	40	130
80162075	75	127	118	42	140
80162077	77	127	122	45	140
80162080	80	127	124	45	140
80162085	85	127	130	52	140
80162090	90	127	136	52	145
80162095	95	127	143	52	145
80162100	100	127	149	58	150
80162105	105	127	155	58	155
80162110	110	127	161	60	160
80162115	115	127	167	62	165
80162120	120	127	176	67	170
80162125	125	127	184	72	175
80162130	130	152	187	72	175
80162135	135	152	194	77	180
80162140	140	152	204	77	180
80162145	145	152	207	83	185
80162150	150	152	214	83	185
80162155	155	152	224	90	190
80162160	160	152	227	90	190
80162165	165	152	234	95	195
80162170	170	152	244	95	195
80162175	175	152	247	100	200
80162180	180	152	254	100	200
80162185	185	152	257	105	210
80162190	190	152	264	105	210
80162200	200	152	274	110	220
80162250	250	152	287	110	220





## 转换头 Adapter

2-1/2" Square Drive
  Square

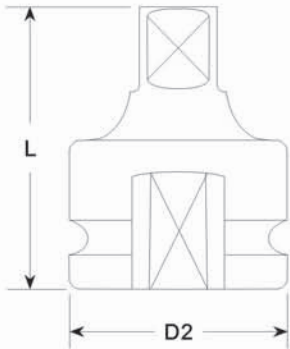

Order No.	<span style="display: inline-block; width: 10px; height: 10px; background-color: black; border: 1px solid black; border-radius: 50%;"></span> Inch	<span style="display: inline-block; width: 10px; height: 10px; background-color: black;"></span> Inch	D2 mm	L mm	Male End Type
80665818	2-1/2"	1-1/2"	127	138	Pin Hole

1/4"

P1-10

3/8"

P11-44

1/2"

P45-92

5/8"

P93-94

3/4"

P95-112

## 延长杆 Extension Bars

2-1/2" Square Drive
  Square

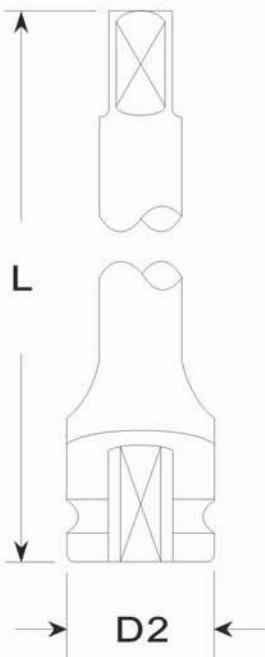

Order No.	<span style="display: inline-block; width: 10px; height: 10px; background-color: black; border: 1px solid black; border-radius: 50%;"></span> Inch	<span style="display: inline-block; width: 10px; height: 10px; background-color: black;"></span> Inch	D2 mm	L mm	Male End Type
80640300	2-1/2"	2-1/2"	127	300	Pin Hole
80640400	2-1/2"	2-1/2"	127	400	Pin Hole
80640500	2-1/2"	2-1/2"	127	500	Pin Hole
80640600	2-1/2"	2-1/2"	127	600	Pin Hole

1"

P113-128

1-1/2"

P129-132

2-1/2"

P133-136

起子套筒

P137-145

起子头

P146-164



- 1/4" P1-10
- 3/8" P11-44
- 1/2" P45-92
- 5/8" P93-94
- 3/4" P95-112
- 1" P113-128
- 1-1/2" P129-132
- 2-1/2" P133-136
- 起子套筒 P137-145
- 起子头 P146-164

## ▶ 套筒固定销 Locking Pin

- 3/8" 套筒固定销  
3/8" Fits Socket Drive End
- 1/2" 套筒固定销  
1/2" Fits Socket Drive End
- 3/4" 套筒固定销  
3/4" Fits Socket Drive End
- 1" 套筒固定销  
1" Fits Socket Drive End
- 1-1/2" 套筒固定销  
1-1/2" Fits Socket Drive End

Order No .	Size $\phi d \times L$ mm	Drive inch	Diameters mm
80932010	$\phi 2.0 \times 10$	1/4"	13
80933015	$\phi 3.0 \times 15$	3/8"	19
80933016	$\phi 3.0 \times 16$	3/8"	20
80933018	$\phi 3.0 \times 18$	3/8"	22
80934020	$\phi 4.0 \times 20$	1/2"	25
80934025	$\phi 4.0 \times 25$	1/2"	30
80935030	$\phi 5.0 \times 30$	3/4"	38
80935036	$\phi 5.0 \times 36$	3/4"	44
80935542	$\phi 5.5 \times 42$	1"	51
80935545	$\phi 5.5 \times 45$	1"	54
80936575	$\phi 6.5 \times 75$	1-1/2"	86

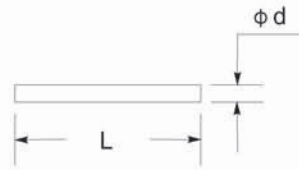
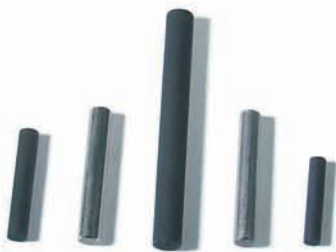

## ▶ 套筒O形环 O-ring

- 3/8" 套筒"o"形环  
3/8" Fits Socket Drive End
- 1/2" 套筒"o"形环  
1/2" Fits Socket Drive End
- 3/4" 套筒"o"形环  
3/4" Fits Socket Drive End
- 1" 套筒"o"形环  
1" Fits Socket Drive End
- 1-1/2" 套筒"o"形环  
1-1/2" Fits Socket Drive End

Order No .	Size $\phi d \times \phi D$ mm	Drive inch	Diameters mm
80942014	$\phi 2.0 \times \phi 14$	1/4"	13
80942420	$\phi 2.4 \times \phi 20$	3/8"	19-20
80942423	$\phi 2.4 \times \phi 23$	3/8"	22
80943125	$\phi 3.1 \times \phi 25$	1/2"	25
80943131	$\phi 3.1 \times \phi 31$	1/2"	30
80944036	$\phi 4.0 \times \phi 36$	3/4"	38
80945045	$\phi 5.0 \times \phi 45$	3/4"	44
80945752	$\phi 5.7 \times \phi 52$	1"	51
80945755	$\phi 5.7 \times \phi 55$	1"	54
80945785	$\phi 5.7 \times \phi 85$	1-1/2"	86

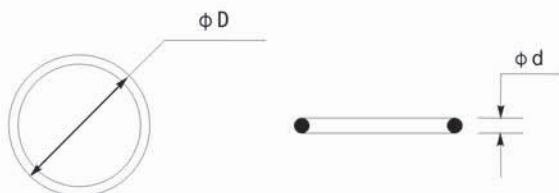



▶ 非标准套筒 Special Purpose Socket For Customized Order

客户特别定制套筒



四方转六角转换头  
Square To Hex Adapter



超短十字套筒  
Extreme Short Philips Bit Socket



开口起子套筒  
Open End Bit Socket



四方转六角转换头  
Quick Change Adapter



快速切换式连接头  
Adapter From Hex To Male Square



旋转防护型延长杆套筒组件  
Extension Arm With Spinning Cover



防护型起子头  
Bit With Free Spinning Cover



防护型锁销式转换杆  
lock pin adapter with spinning cover



定制转换头  
Custom-made Adapter



超大尺寸起子套筒  
Oversized Bit Socket



旋转式整体防护套筒  
Free Spinning Gap Cover Socket



旋转式整体防护套筒  
Free Spinning Gap Cover Socket



十字套筒  
Philips bit socket



双层方向轴套筒  
Steer Wheel Socket



火花塞专用套筒  
Sparking Plug Socket



传动轴键槽套筒  
Axial Nut Socket



六方伸缩式套筒  
Sliding Magnetic Socket For Robot Arm



套筒使用现场  
Working Site



专用工具定制套筒  
Custom-made Socket



套筒研磨  
Grinding Process



微倾斜内六角套筒  
Fast Lead Male Hex Socket



防脱落钢珠式快换接杆  
Quick Change Extension Arm



大尺寸防护套筒  
Oversized Protective Cover Socket



套筒使用现场  
Socket In Use



套筒使用现场  
Socket In Use



1/4"

P1-10



3/8"

P11-44



1/2"

P45-92



5/8"

P93-94



3/4"

P95-112



1"

P113-128



1-1/2"

P129-132



2-1/2"

P133-136



起子套筒

P137-145



起子头

P146-164



# NORMECO INDUSTRIAL SOCKETS

- 1/4" P1-10
- 3/8" P11-44
- 1/2" P45-92
- 5/8" P93-94
- 3/4" P95-112
- 1" P113-128
- 1-1/2" P129-132
- 2-1/2" P133-136
- 起子套筒
- P137-145
- 起子头
- P146-164

## 不带磁起子套筒 Bit Sockets without Magnet

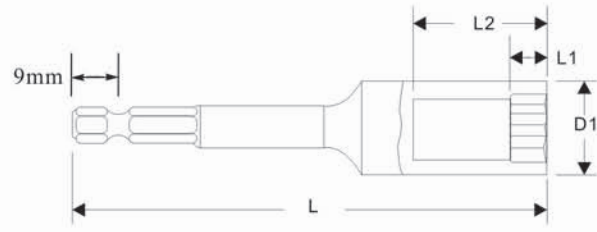

Order No .	Size mm	D1 mm	L1 mm	L2 mm	L mm
80800607	6	10.5	5	26	70
80800707	7	12	7	26	70
80800807	8	13	7.5	26	70
80801007	10	15	7.5	26	70
80801207	12	18	9	26	70
80801307	13	19.5	9	26	70
80801407	14	20	9	26	70

Order No .	Size mm	D1 mm	L1 mm	L2 mm	L mm
80800610	6	10.5	5	26	100
80800710	7	12	7	26	100
80800810	8	13	7.5	26	100
80801010	10	15	7.5	26	100
80801210	12	18	9	26	100
80801310	13	19.5	9	26	100
80801410	14	20	9	26	100

Order No .	Size mm	D1 mm	L1 mm	L2 mm	L mm
80800615	6	10.5	5	26	150
80800715	7	12	7	26	150
80800815	8	13	7.5	26	150
80801015	10	15	7.5	26	150
80801215	12	18	9	26	150
80801315	13	19.5	9	26	150
80801415	14	20	9	26	150

Order No .	Size mm	D1 mm	L1 mm	L2 mm	L mm
80800620	6	10.5	5	26	200
80800720	7	12	7	26	200
80800820	8	13	7.5	26	200
80801020	10	15	7.5	26	200
80801220	12	18	9	26	200
80801320	13	19.5	9	26	200
80801420	14	20	9	26	200

Order No .	Size mm	D1 mm	L1 mm	L2 mm	L mm
80800625	6	10.5	5	26	250
80800725	7	12	7	26	250
80800825	8	13	7.5	26	250
80801025	10	15	7.5	26	250
80801225	12	18	9	26	250
80801325	13	19.5	9	26	250
80801425	14	20	9	26	250

Order No .	Size mm	D1 mm	L1 mm	L2 mm	L mm
80800630	6	10.5	5	26	300
80800730	7	12	7	26	300
80800830	8	13	7.5	26	300
80801030	10	15	7.5	26	300
80801230	12	18	9	26	300
80801330	13	19.5	9	26	300
80801430	14	20	9	26	300



## 固定磁起子套筒 Bit Sockets-Fixed Magnet

Hex

6-Point

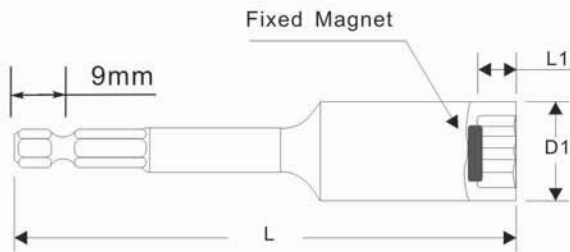

Order No .	Size mm	D1 mm	L1 mm	L mm
80820610	6	10.5	3	100
80820710	7	12	3.5	100
80820810	8	13	4	100
80821010	10	15	4.5	100
80821210	12	18	5	100
80821310	13	19.5	5	100
80821410	14	20	6	100

Order No .	Size mm	D1 mm	L1 mm	L mm
80820615	6	10.5	3	150
80820715	7	12	3.5	150
80820815	8	13	4	150
80821015	10	15	4.5	150
80821215	12	18	5	150
80821315	13	19.5	5	150
80821415	14	20	6	150

Order No .	Size mm	D1 mm	L1 mm	L mm
80820620	6	10.5	3	200
80820720	7	12	3.5	200
80820820	8	13	4	200
80821020	10	15	4.5	200
80821220	12	18	5	200
80821320	13	19.5	5	200
80821420	14	20	6	200

Order No .	Size mm	D1 mm	L1 mm	L mm
80820625	6	10.5	3	250
80820725	7	12	3.5	250
80820825	8	13	4	250
80821025	10	15	4.5	250
80821225	12	18	5	250
80821325	13	19.5	5	250
80821425	14	20	6	250

Order No .	Size mm	D1 mm	L1 mm	L mm
80820630	6	10.5	3	300
80820730	7	12	3.5	300
80820830	8	13	4	300
80821030	10	15	4.5	300
80821230	12	18	5	300
80821330	13	19.5	5	300
80821430	14	20	6	300

Order No .	Size mm	D1 mm	L1 mm	L mm
80820605	6	10.5	3	50
80820705	7	12	3.5	50
80820805	8	13	4	50
80821005	10	15	4.5	50
80821205	12	18	5	50
80821305	13	19.5	5	50
80821405	14	20	6	50

Order No .	Size mm	D1 mm	L1 mm	L mm
80820607	6	10.5	3	70
80820707	7	12	3.5	70
80820807	8	13	4	70
80821007	10	15	4.5	70
80821207	12	18	5	70
80821307	13	19.5	5	70
80821407	14	20	6	70

1/4"

P11-10

3/8"

P11-44

1/2"

P45-92

5/8"

P93-94

3/4"

P95-112

1"

P113-128

1-1/2"

P129-132

2-1/2"

P133-136

起子套筒

P137-145

起子头

P146-164



# NORMECO INDUSTRIAL SOCKETS

- 1/4"
- P1-10
- 3/8"
- P11-44
- 1/2"
- P45-92
- 5/8"
- P93-94
- 3/4"
- P95-112
- 1"
- P113-128
- 1-1/2"
- P129-132
- 2-1/2"
- P133-136
- 起子套筒
- P137-145
- 起子头
- P146-164

## 伸缩磁起子套筒 Bit Sockets-Sliding magnet

Hex 6-Point

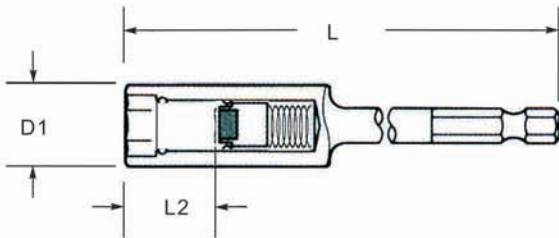
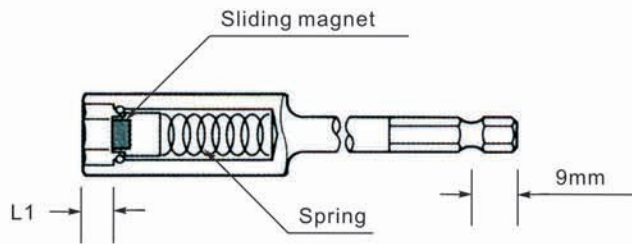
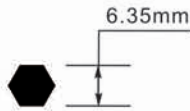

Order No.	Size mm	D1 mm	L1 mm	L2 mm	L mm
80830607	6	10.5	3	24	70
80830707	7	12	3.5	24	70
80830807	8	13	4	24	70
80831007	10	15	4.5	24	70
80831107	11	16.5	5	24	70
80831207	12	18	5	24	70
80831307	13	19.5	5	24	70
80831407	14	20	6	24	70

Order No.	Size mm	D1 mm	L1 mm	L2 mm	L mm
80830610	6	10.5	3	24	100
80830710	7	12	3.5	24	100
80830810	8	13	4	24	100
80831010	10	15	4.5	24	100
80831210	12	18	5	24	100
80831310	13	19.5	5	24	100
80831410	14	20	6	24	100

Order No.	Size mm	D1 mm	L1 mm	L2 mm	L mm
80830615	6	10.5	3	24	150
80830715	7	12	3.5	24	150
80830815	8	13	4	24	150
80831015	10	15	4.5	24	150
80831215	12	18	5	24	150
80831315	13	19.5	5	24	150
80831415	14	20	6	24	150

Order No.	Size mm	D1 mm	L1 mm	L2 mm	L mm
80830620	6	10.5	3	24	200
80830720	7	12	3.5	24	200
80830820	8	13	4	24	200
80831020	10	15	4.5	24	200
80831220	12	18	5	24	200
80831320	13	19.5	5	24	200
80831420	14	20	6	24	200

Order No.	Size mm	D1 mm	L1 mm	L2 mm	L mm
80830625	6	10.5	3	24	250
80830725	7	12	3.5	24	250
80830825	8	13	4	24	250
80831025	10	15	4.5	24	250
80831225	12	18	5	24	250
80831325	13	19.5	5	24	250
80831425	14	20	6	24	250

Order No.	Size mm	D1 mm	L1 mm	L2 mm	L mm
80830630	6	10.5	3	24	300
80830730	7	12	3.5	24	300
80830830	8	13	4	24	300
80831030	10	15	4.5	24	300
80831230	12	18	5	24	300
80831330	13	19.5	5	24	300
80831430	14	20	6	24	300

# NORMECO INDUSTRIAL SOCKETS



## 万向起子套筒 Universal Drive Bit Sockets

Hex

6-Point

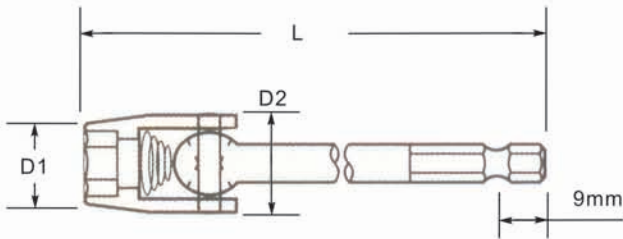
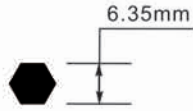

Order No.	Size mm	D1 mm	D2 mm	L mm
80850610	6	10.5	16	100
80850710	7	12	16	100
80850810	8	13	17	100
80851010	10	15	18	100
80851210	12	18	18	100
80851310	13	19.5	19.5	100
80851410	14	20	20	100

Order No.	Size mm	D1 mm	D2 mm	L mm
80850615	6	10.5	16	150
80850715	7	12	16	150
80850815	8	13	17	150
80851015	10	15	18	150
80851215	12	18	18	150
80851315	13	19.5	19.5	150
80851415	14	20	20	150

Order No.	Size mm	D1 mm	D2 mm	L mm
80850620	6	10.5	16	200
80850720	7	12	16	200
80850820	8	13	17	200
80851020	10	15	18	200
80851220	12	18	18	200
80851320	13	19.5	19.5	200
80851420	14	20	20	200



1/4"

P1-10



3/8"

P11-44



1/2"

P45-92



5/8"

P93-94



3/4"

P95-112



1"

P113-128



1-1/2"

P129-132



2-1/2"

P133-136



起子套筒

P137-145

起子头

P146-164



# NORMECO INDUSTRIAL SOCKETS

- 1/4"
- P1-10
- 3/8"
- P11-44
- 1/2"
- P45-92
- 5/8"
- P93-94
- 3/4"
- P95-112
- 1"
- P113-128
- 1-1/2"
- P129-132
- 2-1/2"
- P133-136
- 起子套筒
- P137-145
- 起子头
- P146-164

## ▶ 不带磁十二角起子套筒 Bit 12-point Sockets-Without magnet

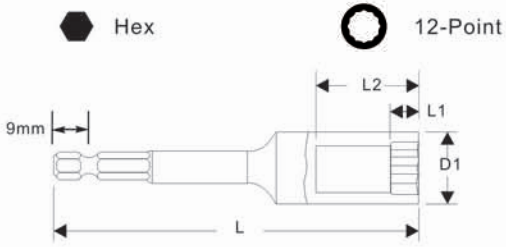

Order No.	Size mm	D1 mm	L1 mm	L2 mm	L mm
80806607	6	10.5	5	26	70
80806707	7	12	7	26	70
80806807	8	13	7.5	26	70
80807007	10	15	7.5	26	70
80807207	12	18	9	26	70
80807307	13	19.5	9	26	70
80807407	14	20	9	26	70

## ▶ 固定磁十二角起子套筒 Bit 12-point Sockets-fixed magnet

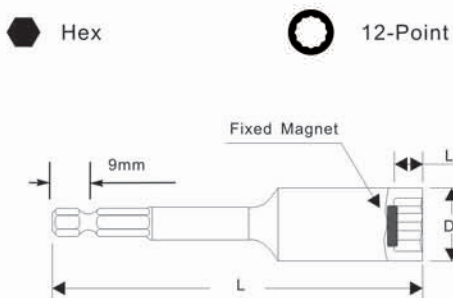

Order No.	Size mm	D1 mm	L1 mm	L2 mm	L mm
80806610	6	10.5	5	26	100
80806710	7	12	7	26	100
80806810	8	13	7.5	26	100
80807010	10	15	7.5	26	100
80807210	12	18	9	26	100
80807310	13	19.5	9	26	100
80807410	14	20	9	26	100

Order No.	Size mm	D1 mm	L1 mm	L2 mm	L mm
80806615	6	10.5	5	26	150
80806715	7	12	7	26	150
80806815	8	13	7.5	26	150
80807015	10	15	7.5	26	150
80807215	12	18	9	26	150
80807315	13	19.5	9	26	150
80807415	14	20	9	26	150

Order No.	Size mm	D1 mm	L1 mm	L2 mm	L mm
80806620	6	10.5	5	26	200
80806720	7	12	7	26	200
80806820	8	13	7.5	26	200
80807020	10	15	7.5	26	200
80807220	12	18	9	26	200
80807320	13	19.5	9	26	200
80807420	14	20	9	26	200

Order No.	Size mm	D1 mm	L1 mm	L mm
80826607	6	10.5	3	70
80826707	7	12	3.5	70
80826807	8	13	4	70
80827007	10	15	4.5	70
80827207	12	18	5	70
80827307	13	19.5	5	70
80827407	14	20	6	70

Order No.	Size mm	D1 mm	L1 mm	L mm
80826610	6	10.5	3	100
80826710	7	12	3.5	100
80826810	8	13	4	100
80827010	10	15	4.5	100
80827210	12	18	5	100
80827310	13	19.5	5	100
80827410	14	20	6	100



快换穿心套筒 Quick-change Bit Through Sockets

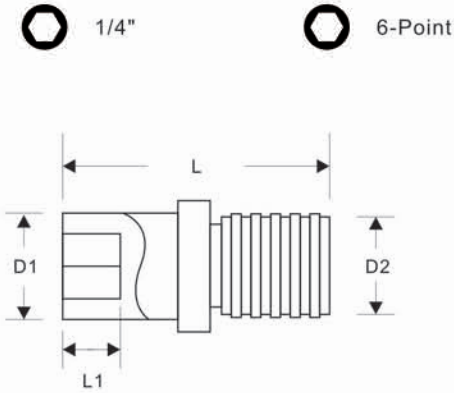

Order No.	mm	mm	D1 mm	D2 mm	L1 mm	L mm	Magnet
80722008A	1/4"	8	13	17.5	3.5	45	3-side Mgnt.
80722010A	1/4"	10	15	17.5	4	45	3-side Mgnt.
80722010B	1/4"	10	15	17.5	4	45	Mgnt. ring
80722012A	1/4"	12	17.5	17.5	5	45	3-side Mgnt.
80722012B	1/4"	12	17.5	17.5	5	45	Mgnt. ring
80722013A	1/4"	13	19	17.5	5	45	3-side Mgnt.
80722013B	1/4"	13	19	17.5	5	45	Mgnt. ring
80722014A	1/4"	14	20	17.5	6	45	3-side Mgnt.
80722014B	1/4"	14	20	17.5	6	45	Mgnt. ring

十字螺丝与六角螺丝紧固，两种作业快速切换。  
Swift change between phillips screw and hexagon screw fastening.

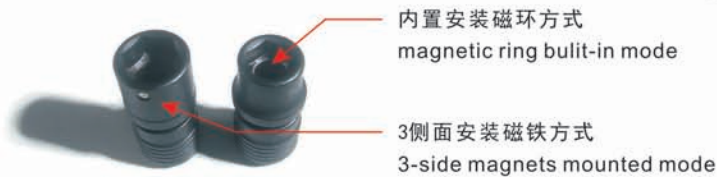
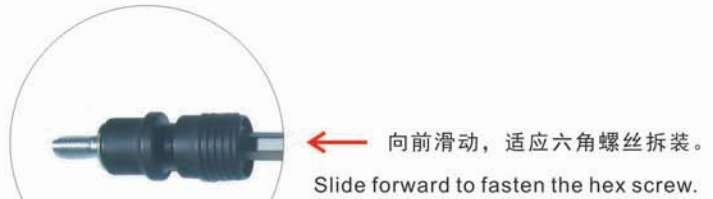
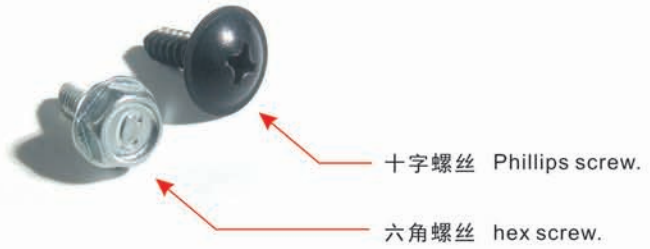

PAT. ZL2020 1 0846343.5

1/4"
P1-10
3/8"
P11-44
1/2"
P45-92
5/8"
P93-94
3/4"
P95-112
1"
P113-128
1-1/2"
P129-132
2-1/2"
P133-136
起子套筒
P137-145
起子头
P146-164



# NORMECO INDUSTRIAL SOCKETS

- 1/4"
- P1-10
- 3/8"
- P11-44
- 1/2"
- P45-92
- 5/8"
- P93-94
- 3/4"
- P95-112
- 1"
- P113-128
- 1-1/2"
- P129-132
- 2-1/2"
- P133-136
- 起子头
- P137-145
- 起子头
- P146-164

## 转换头 Hex Extensions

Hex Square

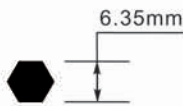

Order No.	Hex Inch	Square Inch	L mm	Male End Type
80668710	1/4"	1/4"	50	Steel Ball
80668715	1/4"	1/4"	75	Steel Ball
80668720	1/4"	1/4"	100	Steel Ball
80668725	1/4"	1/4"	125	Steel Ball
80668730	1/4"	1/4"	150	Steel Ball
80668735	1/4"	1/4"	200	Steel Ball
<b>Order No. Hex Inch Square Inch L mm Male End Type</b>				
80668740	1/4"	1/4"	50	Lock Pin
80668745	1/4"	1/4"	75	Lock Pin
80668750	1/4"	1/4"	100	Lock Pin
80668755	1/4"	1/4"	125	Lock Pin
80668760	1/4"	1/4"	150	Lock Pin
80668765	1/4"	1/4"	200	Lock Pin
<b>Order No. Hex Inch Square Inch L mm Male End Type</b>				
80668770A	1/4"	1/4"	50	Pin Hole
80668770B	1/4"	1/4"	75	Pin Hole
80668770C	1/4"	1/4"	100	Pin Hole
80668770D	1/4"	1/4"	125	Pin Hole
80668770E	1/4"	1/4"	150	Pin Hole
80668770F	1/4"	1/4"	200	Pin Hole

Order No.	Hex Inch	Square Inch	L mm	Male End Type
80668780	1/4"	3/8"	50	Steel Ball
80668785	1/4"	3/8"	75	Steel Ball
80668790	1/4"	3/8"	100	Steel Ball
80668800	1/4"	3/8"	125	Steel Ball
80668805	1/4"	3/8"	150	Steel Ball
80668810	1/4"	3/8"	200	Steel Ball

Order No.	Hex Inch	Square Inch	L mm	Male End Type
80668815	1/4"	3/8"	50	Lock Pin
80668820	1/4"	3/8"	75	Lock Pin
80668825	1/4"	3/8"	100	Lock Pin
80668830	1/4"	3/8"	125	Lock Pin
80668835	1/4"	3/8"	150	Lock Pin
80668840	1/4"	3/8"	200	Lock Pin

Order No.	Hex Inch	Square Inch	L mm	Male End Type
80668842A	1/4"	3/8"	50	Pin Hole
80668842B	1/4"	3/8"	75	Pin Hole
80668842C	1/4"	3/8"	100	Pin Hole
80668842D	1/4"	3/8"	125	Pin Hole
80668842E	1/4"	3/8"	150	Pin Hole
80668842F	1/4"	3/8"	200	Pin Hole

Order No.	Hex Inch	Square Inch	L mm	Male End Type
80668845	1/4"	1/2"	50	Steel Ball
80668850	1/4"	1/2"	75	Steel Ball
80668855	1/4"	1/2"	100	Steel Ball
80668860	1/4"	1/2"	125	Steel Ball
80668865	1/4"	1/2"	150	Steel Ball
80668870	1/4"	1/2"	200	Steel Ball

Order No.	Hex Inch	Square Inch	L mm	Male End Type
80668875	1/4"	1/2"	50	Lock Pin
80668880	1/4"	1/2"	75	Lock Pin
80668885	1/4"	1/2"	100	Lock Pin
80668890	1/4"	1/2"	125	Lock Pin
80668895	1/4"	1/2"	150	Lock Pin
80668900	1/4"	1/2"	200	Lock Pin

Order No.	Hex Inch	Square Inch	L mm	Male End Type
80668902A	1/4"	1/2"	50	Pin Hole
80668902B	1/4"	1/2"	75	Pin Hole
80668902C	1/4"	1/2"	100	Pin Hole
80668902D	1/4"	1/2"	125	Pin Hole
80668902E	1/4"	1/2"	150	Pin Hole
80668902F	1/4"	1/2"	200	Pin Hole

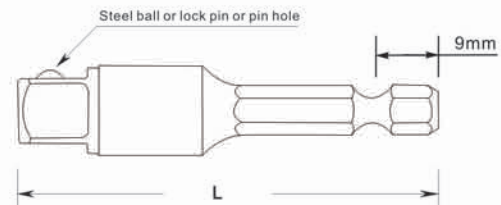

# NORMECO INDUSTRIAL SOCKETS



## 不带磁起子套筒 Bit Sockets without Magnet

Hex

6-Point

● 维修级 Maintenance Purpose

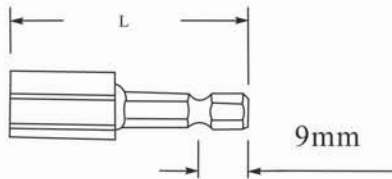

Order No.	Size mm	L mm
8078.06050N	6	50
Order No.	Size mm	L mm
8078.06065N	6	65
8078.07065N	7	65
8078.08065N	8	65
8078.10065N	10	65
8078.12065N	12	65
8078.13065N	13	65
8078.14065N	14	65
Order No.	Size mm	L mm
8078.06100N	6	100
8078.07100N	7	100
8078.08100N	8	100
8078.10100N	10	100
8078.12100N	12	100
8078.13100N	13	100
8078.14100N	14	100
Order No.	Size mm	L mm
8078.08150N	8	150
8078.10150N	10	150
8078.12150N	12	150
8078.13150N	13	150
8078.14150N	14	150
Order No.	Size mm	L mm
8078.08200N	8	200
Order No.	Size mm	L mm
8078.10250N	10	250
8078.12250N	12	250
8078.13250N	13	250
Order No.	Size mm	L mm
8078.13300N	13	300

● 维修级 Maintenance Purpose

维修级产品适用于维修、家居及工作室等较低使用频次及使用强度的场所。Maintenance-grade products are suitable for working situation with low frequency and intensity of use, such as maintenance, DIY and studio.

1/4"

P1-10

3/8"

P11-44

1/2"

P45-92

5/8"

P93-94

3/4"

P95-112

1"

P113-128

1-1/2"

P129-132

2-1/2"

P133-136

起子套筒

P137-145

起子头

P146-164



# NORMECO INDUSTRIAL SOCKETS

- 1/4"
- P1-10
- 3/8"
- P11-44
- 1/2"
- P45-92
- 5/8"
- P93-94
- 3/4"
- P95-112
- 1"
- P113-128
- 1-1/2"
- P129-132
- 2-1/2"
- P133-136
- 145
- P137-145
- 起子头
- P146-164

## 固定磁起子套筒 Bit Sockets-Fixed Magnet

Hex

6-Point

● 维修级 Maintenance Purpose

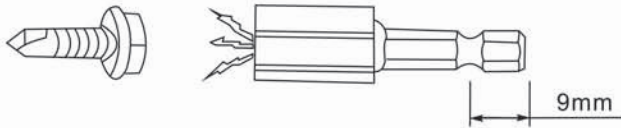

Order No .	Size mm	L mm
8079.07065M	7	65
8079.08065M	8	65
8079.10065M	10	65
8079.11065M	11	65
8079.12065M	12	65
8079.13065M	13	65
8079.14065M	14	65

Order No .	Size mm	L mm
8079.07100M	7	100
8079.08100M	8	100
8079.10100M	10	100
8079.12100M	12	100
8079.13100M	13	100
8079.14100M	14	100
8079.16100M	16	100

Order No .	Size mm	L mm
8079.08150M	8	150
8079.12150M	12	150
8079.13150M	13	150
8079.14150M	14	150

Order No .	Size mm	L mm
8079.08200M	8	200

● 维修级 Maintenance Purpose

维修级产品适用于维修、家居及工作室等较低使用频次及使用强度的场所。Maintenance-grade products are suitable for working situation with low frequency and intensity of use, such as maintenance, DIY and studio.



# 工业装配级起子头

## INDUSTRIAL BITS



警告 WARNING

使用时请穿戴好保护身体各部位的相应防护用品，严禁在没有任何保护的情况下使用。  
Always wear safety goggles when using impact tools. Do not hold socket while in use.

本目录中的所有参数如有变动，恕不另行通知，本公司保留对样本进行修改的权利。  
Product improvement is continuing. Designs and specifications are changing without prior notice.  
The company reserves the right to modify the catalogue.

1/4"

P1-10

3/8"

P11-44

1/2"

P45-92

5/8"

P93-94

3/4"

P95-112

1"

P113-128

1-1/2"

P129-132

2-1/2"

P133-136

起子头

P137-145

起子头

P146-164



# NORMECO INDUSTRIAL BITS

- 1/4"
- P1-10
- 3/8"
- P11-44
- 1/2"
- P45-92
- 5/8"
- P93-94
- 3/4"
- P95-112
- 1"
- P113-128
- 1-1/2"
- P129-132
- 2-1/2"
- P133-136
- 起子套筒
- P137-145
- 起子头
- P146-164

**▶ 十字起子头 (1/4") Phillips Bits**

1/4" (6.35mm)

单头1/4", 材质S2 磁性  
Single tip 1/4" Material: S2 Magnetic

+

Phillips

Order No.	头部规格	L mm
7106PH025	PH0	25
7106PH125	PH1	25
7106PH225	PH2	25
7106PH325	PH3	25
7106PH425	PH4	25



**▶ 十字起子头 (1/4") Phillips Bits**

1/4" (6.35mm)

单头1/4", 材质S2 磁性  
Single tip 1/4" Material: S2 Magnetic

+

Phillips

Order No.	头部规格	d	L mm
7109PH135050	PH1	3.5	50
7109PH135075	PH1	3.5	75
7109PH135100	PH1	3.5	100
7109PH140050	PH1	4.0	50
7109PH140075	PH1	4.0	75
7109PH140100	PH1	4.0	100
7109PH145050	PH1	4.5	50
7109PH145075	PH1	4.5	75
7109PH145100	PH1	4.5	100
7109PH145150	PH1	4.5	150
7109PH150050	PH1	5.0	50
7109PH150075	PH1	5.0	75
7109PH150100	PH1	5.0	100
7109PH230050	PH2	3.0	50
7109PH230075	PH2	3.0	75
7109PH240050	PH2	4.0	50
7109PH240075	PH2	4.0	75
7109PH240100	PH2	4.0	100
7109PH245050	PH2	4.5	50
7109PH245075	PH2	4.5	75
7109PH245100	PH2	4.5	100
7109PH245150	PH2	4.5	150
7109PH245200	PH2	4.5	200
7109PH250050	PH2	5.0	50
7109PH250075	PH2	5.0	75
7109PH250100	PH2	5.0	100
7109PH260050	PH2	6.0	50
7109PH260075	PH2	6.0	75
7109PH260100	PH2	6.0	100
7109PH260150	PH2	6.0	150
7109PH260200	PH2	6.0	200
7109PH360050	PH3	6.0	50
7109PH360075	PH3	6.0	75
7109PH360100	PH3	6.0	100
7109PH360150	PH3	6.0	150
7109PH360200	PH3	6.0	200

Order No.	头部规格	d	L mm
7109PH016050	PH0	1.6	50
7109PH020050	PH0	2.0	50
7109PH020075	PH0	2.0	75
7109PH025050	PH0	2.5	50
7109PH025075	PH0	2.5	75
7109PH030050	PH0	3.0	50
7109PH030075	PH0	3.0	75
7109PH030100	PH0	3.0	100
7109PH125050	PH1	2.5	50
7109PH125075	PH1	2.5	75
7109PH130050	PH1	3.0	50
7109PH130075	PH1	3.0	75
7109PH130100	PH1	3.0	100



## ▶ 十字起子头 (1/4") Phillips Bits

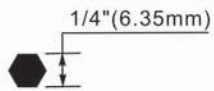

双头1/4", 材质S2 磁性  
Double Tip 1/4" Material: S2 Magnetic

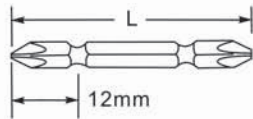

Order No.	头部规格	Shape	L mm
7112PH2050	PH2	短槽	50
7112PH2065	PH2	短槽	65
7112PH2075	PH2	短槽	75
7112PH2100	PH2	短槽	100
7112PH2150	PH2	短槽	150
7112PH2200	PH2	短槽	200
7112PH2250	PH2	短槽	250
7112PH2300	PH2	短槽	300

Order No.	头部规格	Shape	L mm
7112PH3050	PH3	短槽	50
7112PH3065	PH3	短槽	65
7112PH3075	PH3	短槽	75
7112PH3100	PH3	短槽	100
7112PH3150	PH3	短槽	150
7112PH3200	PH3	短槽	200
7112PH3250	PH3	短槽	250
7112PH3300	PH3	短槽	300

## ▶ 十字起子头 (1/4") Phillips Bits

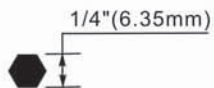

双头1/4", 材质S2 磁性  
Double Tip 1/4" Material: S2 Magnetic

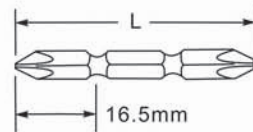

Order No.	头部规格	Shape	L mm
7115PH1100	PH1	长槽	100
7115PH2050	PH2	长槽	50
7115PH2065	PH2	长槽	65
7115PH2075	PH2	长槽	75
7115PH2100	PH2	长槽	100
7115PH2150	PH2	长槽	150
7115PH2200	PH2	长槽	200
7115PH2250	PH2	长槽	250
7115PH2300	PH2	长槽	300
7115PH3050	PH3	长槽	50
7115PH3065	PH3	长槽	65
7115PH3075	PH3	长槽	75
7115PH3100	PH3	长槽	100
7115PH3150	PH3	长槽	150
7115PH3200	PH3	长槽	200
7115PH3250	PH3	长槽	250
7115PH3300	PH3	长槽	300

1/4"

P11-10

3/8"

P11-44

1/2"

P45-92

5/8"

P93-94

3/4"

P95-112

1"

P113-128

1-1/2"

P129-132

2-1/2"

P133-136

起子套筒

P137-145

起子头

P146-164



# NORMECO INDUSTRIAL BITS

- 1/4" P1-10
- 3/8" P11-44
- 1/2" P45-92
- 5/8" P93-94
- 3/4" P95-112
- 1" P113-128
- 1-1/2" P129-132
- 2-1/2" P133-136
- 起子套筒 P137-145
- 起子头 P146-164

## 米字起子头 (1/4") Pozidriv Bits

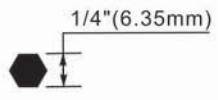

单头1/4", 材质S2 磁性  
Single tip 1/4" Material: S2 Magnetic

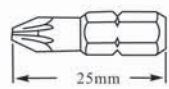

Order No.	头部规格	L mm
7117PZ025	PZ0	25
7117PZ125	PZ1	25
7117PZ225	PZ2	25
7117PZ325	PZ3	25
7117PZ425	PZ4	25



## 一字起子头 (1/4") Slotted

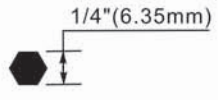

单头1/4", 材质S2 磁性  
Single tip 1/4" Material: S2 Magnetic

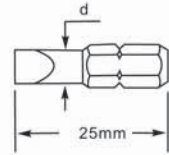

Order No.	头部规格	d mm	L mm
711730	SL3	3	25
711740	SL4	4	25
711750	SL5	5	25
711760	SL6	6	25



## 一字起子头 (1/4") Slotted

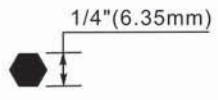

单头1/4", 材质S2 磁性  
Single tip 1/4" Material: S2 Magnetic

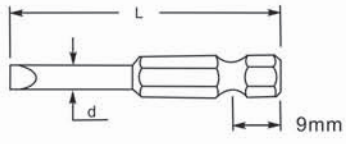

Order No.	头部规格	d mm	L mm
71193050	SL3	3	50
71193075	SL3	3	75
71194050	SL4	4	50
71194075	SL4	4	75
71195050	SL5	5	50
71195075	SL5	5	75
71196050	SL6	6	50
71196075	SL6	6	75





## ▶ 内六角起子头(1/4") Hex Bits

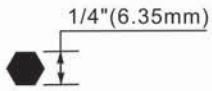

单头1/4", 材质S2 磁性  
Single tip 1/4" Material: S2 Magnetic

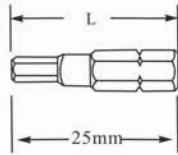

Order No.	Size mm	L mm
7121H30	3.0	25
7121H40	4.0	25
7121H50	5.0	25
7121H60	6.0	25

## ▶ 内六角起子头(1/4") Hex Bits

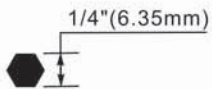

单头1/4", 材质S2 磁性  
Single tip 1/4" Material: S2 Magnetic

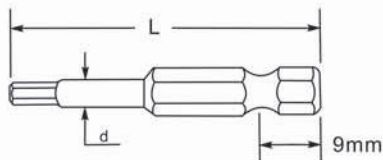

Order No.	Size mm	d	L mm
7123H1520050	1.5	2.0	50
7123H2030050	2.0	3.0	50
7123H2030065	2.0	3.0	65
7123H2030075	2.0	3.0	75
7123H2030100	2.0	3.0	100
7123H2530050	2.5	3.0	50
7123H2535065	2.5	3.5	65
7123H2535075	2.5	3.5	75
7123H2535100	2.5	3.5	100
7123H3035050	3.0	3.5	50
7123H3035065	3.0	3.5	65
7123H3035075	3.0	3.5	75
7123H3035100	3.0	3.5	100
7123H4050050	4.0	5.0	50
7123H4050065	4.0	5.0	65
7123H4050075	4.0	5.0	75
7123H4050100	4.0	5.0	100
7123H5060050	5.0	6.0	50
7123H5060065	5.0	6.0	65
7123H5060075	5.0	6.0	75
7123H5060100	5.0	6.0	100
7123H6000050	6.0	-	50
7123H6000065	6.0	-	65
7123H6000075	6.0	-	75
7123H6000100	6.0	-	100

1/4"

P1-10

3/8"

P11-44

1/2"

P45-92

5/8"

P93-94

3/4"

P95-112

1"

P113-128

1-1/2"

P129-132

2-1/2"

P133-136

起子套筒

P137-145

起子头

P146-164



# NORMECO INDUSTRIAL BITS

1/4"  
P1-10  
3/8"  
P11-44  
1/2"  
P45-92

## ▶ 内星型起子头(1/4") Torx Bits

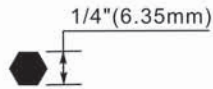

单头1/4", 材质S2 磁性  
Single tip 1/4" Material: S2 Magnetic

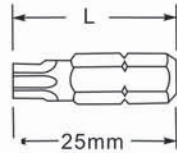

Order No.	T	L mm
7125T05	T5	25
7125T06	T6	25
7125T07	T7	25
7125T08	T8	25
7125T09	T9	25
7125T10	T10	25
7125T15	T15	25
7125T20	T20	25
7125T25	T25	25
7125T27	T27	25
7125T30	T30	25
7125T40	T40	25
7125T45	T45	25
7125T50	T50	25

5/8"  
P93-94  
3/4"  
P95-112  
1"  
P113-128  
1-1/2"  
P129-132  
2-1/2"

## ▶ 内星型起子头(1/4") Torx Bits

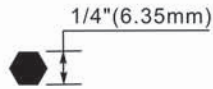

单头1/4", 材质S2 磁性  
Single tip 1/4" Material: S2 Magnetic

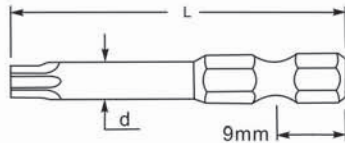

Order No.	T	d mm	L mm
7127T10050	T10	3	50
7127T10075	T10	3	75
7127T10100	T10	4.5	100
7127T10150	T10	4.5	150
7127T15050	T15	4.5	50
7127T15075	T15	4.5	75
7127T15100	T15	4.5	100
7127T20050	T20	4.5	50
7127T20075	T20	4.5	75
7127T20100	T20	5.0	100
7127T20150	T20	5.0	150
7127T25050	T25	5.0	50
7127T25075	T25	5.0	75
7127T25100	T25	5.0	100
7127T25150	T25	5.0	150
7127T27050	T27	5.5	50
7127T27075	T27	5.5	75
7127T27100	T27	5.5	100
7127T30050	T30	6.0	50
7127T30075	T30	6.0	75
7127T30100	T30	6.0	100
7127T30150	T30	6.0	150
7127T40050	T40	-	50
7127T40075	T40	-	75
7127T40100	T40	-	100
7127T40150	T40	-	150
7127T45050	T45	-	50
7127T45075	T45	-	75
7127T45100	T45	-	100
7127T50050	T50	-	50
7127T50075	T50	-	75
7127T50100	T50	-	100
7127T55075	T55	-	75
7127T55100	T55	-	100

Order No.	T	d mm	L mm
7127T05050	T5	2.0	50
7127T05075	T5	2.5	75
7127T06050	T6	3.0	50
7127T06075	T6	3.0	75
7127T07050	T7	3.0	50
7127T07075	T7	3.0	75
7127T08050	T8	3.0	50
7127T08075	T8	3.0	75
7127T08100	T8	3.0	100
7127T09050	T9	4.0	50
7127T09075	T9	4.0	75
7127T09100	T9	4.0	100

起子套筒

P137-145

起子头

P146-164



▶ 内星型中空起子头(1/4") Torx Bits-Tamper proof

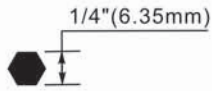

单头1/4", 材质S2 磁性  
Single tip 1/4" Material: S2 Magnetic

 Torx Tamper Proof

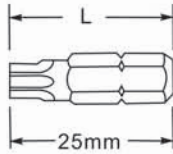

Order No.	T	L mm
7129T06	T6	25
7129T07	T7	25
7129T08	T8	25
7129T10	T10	25
7129T15	T15	25
7129T20	T20	25
7129T25	T25	25
7129T27	T27	25
7129T30	T30	25
7129T40	T40	25

▶ 内星型中空起子头(1/4") Torx Bits-Tamper proof

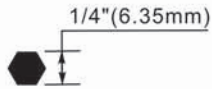

单头1/4", 材质S2 磁性  
Single tip 1/4" Material: S2 Magnetic

 Torx Tamper Proof

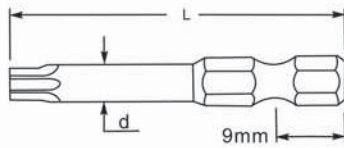

Order No.	T	d mm	L mm
7131T06050	T6	3.0	50
7131T07050	T7	3.0	50
7131T08050	T8	3.0	50
7131T08075	T8	3.0	75
7131T10050	T10	4.5	50
7131T10075	T10	4.5	75
7131T10100	T10	4.5	100
7131T15050	T15	4.5	50
7131T15075	T15	4.5	75
7131T15100	T15	4.5	100
7131T20050	T20	4.5	50
7131T20075	T20	4.5	75
7131T20100	T20	5.0	100
7131T25050	T25	5.0	50
7131T25075	T25	5.0	75
7131T25100	T25	5.0	100
7131T27050	T27	5.5	50
7131T27075	T27	5.5	75
7131T27100	T27	5.5	100
7131T30050	T30	6.0	50
7131T30075	T30	6.0	75
7131T30100	T30	6.0	100
7131T40050	T40	-	50
7131T40075	T40	-	75
7131T40100	T40	-	100



1/4"

P1-10



3/8"

P11-44



1/2"

P45-92



5/8"

P93-94



3/4"

P95-112



1"

P113-128



1-1/2"

P129-132



2-1/2"

P133-136



起子套筒

P137-145

起子头

P146-164



# NORMECO INDUSTRIAL BITS

- 1/4"
- P1-10
- 3/8"
- P11-44
- 1/2"
- P45-92
- 5/8"
- P93-94
- 3/4"
- P95-112
- 1"
- P113-128
- 1-1/2"
- P129-132
- 2-1/2"
- P133-136
- 起子套筒
- P137-145
- P146-164

## ▶ 内四角起子头(1/4") Square Bits

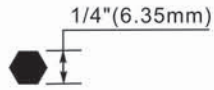

单头1/4", 材质S2 磁性  
Single tip 1/4" Material: S2 Magnetic

Order No.	Size	L mm
7133S0	S0	25
7133S1	S1	25
7133S2	S2	25
7133S3	S3	25

□ Square

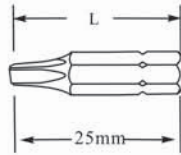

## ▶ 内四角起子头(1/4") Square Bits

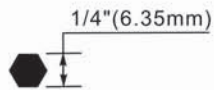

单头1/4", 材质S2 磁性  
Single tip 1/4" Material: S2 Magnetic

Order No.	Size	L mm
7135S0050	S0	50
7135S1050	S1	50
7135S2050	S2	50
7135S3050	S3	50

□ Square

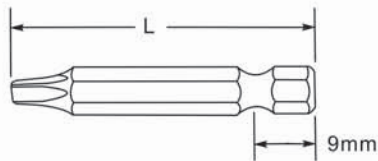

## ▶ 内十二角起子头(1/4") Spline Bits

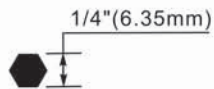

单头1/4", 材质S2 磁性  
Single tip 1/4" Material: S2 Magnetic

Order No.	T	L mm
7137M04	M4	25
7137M05	M5	25
7137M06	M6	25

⊙ Spline

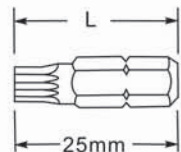



## 冲击型十字起子头 Impact Phillips Bits

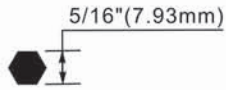

单头5/16" (7.93mm), 材质S2 磁性  
Single tip 5/16" Material: S2 Magnetic



Order No.	头部规格	L mm
7152PH280	PH2	80
7152PH380	PH3	80

## 冲击型一字起子头 Impact Slotted Bits

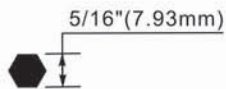

单头5/16" (7.93mm), 材质S2 磁性  
Single tip 5/16" Material: S2 Magnetic



Order No.	头部规格	L mm
7153SL880	SL8	80

## 内星型起子头(5/16") Torx Bits

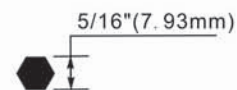

单头5/16", 材质S2 磁性  
Single tip 5/16" Material: S2 Magnetic

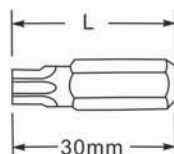

Order No.	T	L mm
7156T10	T10	30
7156T15	T15	30
7156T20	T20	30
7156T25	T25	30
7156T27	T27	30
7156T30	T30	30
7156T40	T40	30
7156T45	T45	30
7156T50	T50	30
7156T55	T55	30

- 1/4"
- P1-10
- 3/8"
- P11-44
- 1/2"
- P45-92
- 5/8"
- P93-94
- 3/4"
- P95-112
- 1"
- P113-128
- 1-1/2"
- P129-132
- 2-1/2"
- P133-136
- 起子套筒
- P137-145
- 起子头
- P146-164



# NORMECO INDUSTRIAL BITS

- 1/4" P1-10
- 3/8" P11-44
- 1/2" P45-92
- 5/8" P93-94
- 3/4" P95-112
- 1" P113-128
- 1-1/2" P129-132
- 2-1/2" P133-136
- 起子套筒 P137-145
- 起子头 P146-164

## ▶ 内星型起子头 (5/16") Torx Plus Bits

5/16"(7.93mm) 单头5/16", 材质S2 磁性  
Single tip 5/16" Material: S2 Magnetic

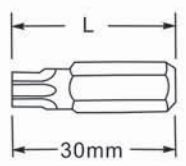

Order No.	T	L mm
7156TP40	TP40	30
7156TP45	TP45	30
7156TP50	TP50	30

## ▶ 内六角起子头 (5/16") Hex Bits

5/16"(7.93mm) 单头5/16" (7.93mm), 材质S2 磁性  
Single tip 5/16" Material: S2 Magnetic

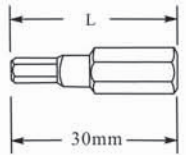

Order No.	Size mm	L mm
7155H30	3.0	30
7155H40	4.0	30
7155H50	5.0	30
7155H60	6.0	30
7155H70	7.0	30
7155H80	8.0	30

## ▶ 内十二角起子头 (5/16") Spline Bits

5/16"(7.93mm) 单头5/16" (7.93mm), 材质S2 磁性  
Single tip 5/16" Material: S2 Magnetic

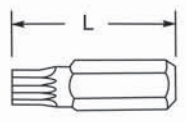

Order No.	T	L mm
7157M0530	M5	30
7157M0570	M5	70
7157M0630	M6	30
7157M0670	M6	70
7157M0830	M8	30
7157M0870	M8	70



## ▶ 单头十字起子头 Phillips Bits

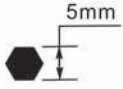

单头5mm, 材质S2 磁性  
Single tip 5mm Material: S2 Magnetic

Order No.	头部规格	d	L mm
7163PH0050	PH0	2.0	50
7163PH1070	PH1	3.0	70
7163PH1100	PH1	3.0	100
7163PH2100	PH2	4.0	100
7163PH2150	PH2	4.0	150

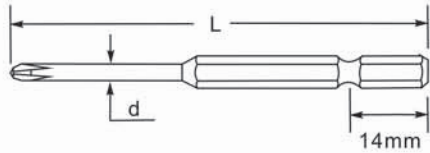

## ▶ 双头十字起子头 Phillips Bits

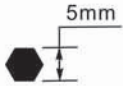

双头5mm, 材质S2 磁性  
Double tips 5mm Material: S2 Magnetic

Order No.	头部规格	L mm
7165PH1070	PH1	70
7165PH2070	PH2	70
7165PH2100	PH2	100
7165PH2150	PH2	150
7165PH2200	PH2	200

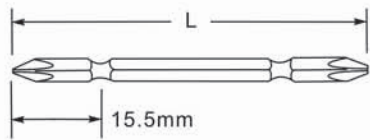

1/4"



P1-10



3/8"



P11-44



1/2"



P45-92



5/8"



P93-94



3/4"



P95-112



1"



P113-128



1-1/2"



P129-132



2-1/2"



P133-136



起子套筒



P137-145



起子头



P146-164



# NORMECO INDUSTRIAL BITS

- 1/4" P1-10
- 3/8" P11-44
- 1/2" P45-92
- 5/8" P93-94
- 3/4" P95-112
- 1" P113-128
- 1-1/2" P129-132
- 2-1/2" P133-136
- 起子套筒 P137-145
- P146-164

## ▶ 内星型起子头 Torx Bits

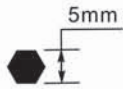

单头5mm, 材质S2 磁性  
Single tip 5mm Material: S2 Magnetic

Order No.	T	d mm	L mm
7167T6075	T6	2.0	75
7167T8075	T8	3.0	75
7167T9075	T9	3.0	75

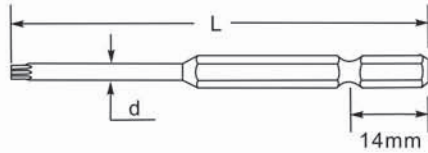

## ▶ 内六角起子头 Hex Bits

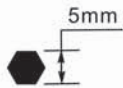

单头5mm, 材质S2 磁性  
Single tip 5mm Material: S2 Magnetic

Order No.	Size mm	d	L mm
7169H30070	3.0	3.5	70
7169H40070	4.0	5.0	70

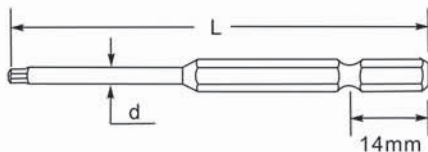



## ▶ 十字起子头

### Shank Drive Bits

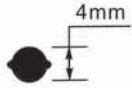

单头4mm, 材质S2 磁性  
Single tip 4mm Material: S2 Magnetic



Phillips

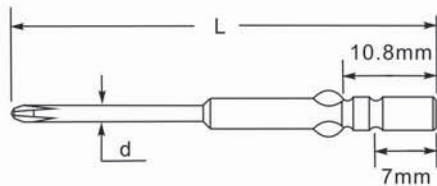

### Order No.

### 头部规格

### d

### L mm

7403PH015040	PH0	1.5	40
7403PH015060	PH0	1.5	60
7403PH017040	PH0	1.7	40
7403PH017060	PH0	1.7	60
7403PH017080	PH0	1.7	80
7403PH020040	PH0	2.0	40
7403PH020060	PH0	2.0	60
7403PH020080	PH0	2.0	80
7403PH025040	PH0	2.5	40
7403PH025060	PH0	2.5	60
7403PH025080	PH0	2.5	80
7403PH025100	PH0	2.5	100
7403PH120040	PH1	2.0	40
7403PH120060	PH1	2.0	60
7403PH120080	PH1	2.0	80
7403PH125040	PH1	2.5	40
7403PH125060	PH1	2.5	60
7403PH130040	PH1	3.0	40
7403PH130060	PH1	3.0	60
7403PH130080	PH1	3.0	80
7403PH130100	PH1	3.0	100
7403PH140040	PH1	4.0	40
7403PH140060	PH1	4.0	60
7403PH140080	PH1	4.0	80
7403PH140100	PH1	4.0	100
7403PH140150	PH1	4.0	150
7403PH140200	PH1	4.0	200
7403PH230040	PH2	3.0	40
7403PH230060	PH2	3.0	60
7403PH240040	PH2	4.0	40
7403PH240060	PH2	4.0	60
7403PH240080	PH2	4.0	80
7403PH240100	PH2	4.0	100
7403PH240150	PH2	4.0	150
7403PH240200	PH2	4.0	200

## ▶ 一字起子头

### Shank Drive Bits

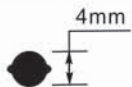

单头4mm, 材质S2 磁性  
Single tip 4mm Material: S2 Magnetic



Slotted

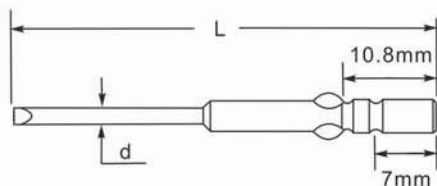

### Order No.

### 头部规格

### d mm

### L mm

74061540	SL1.5	1.5	40
74062040	SL2.0	2.0	40
74062540	SL2.5	2.5	40
74063040	SL3.0	3.0	40
74064040	SL4.0	4.0	40



1/4"

P1-10



3/8"

P11-44



1/2"

P45-92



5/8"

P93-94



3/4"

P95-112



1"

P113-128



1-1/2"

P129-132



2-1/2"

P133-136



起子套筒

P137-145

起子头

P146-164



# NORMECO INDUSTRIAL BITS

- 1/4" P1-10
- 3/8" P11-44
- 1/2" P45-92
- 5/8" P93-94
- 3/4" P95-112
- 1" P113-128
- 1-1/2" P129-132
- 2-1/2" P133-136
- 起子套筒
- P137-145
- P146-164

## ▶ 内六角起子头 Hex Bits

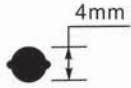

单头4mm, 材质S2 磁性  
Single tip 4mm Material: S2 Magnetic

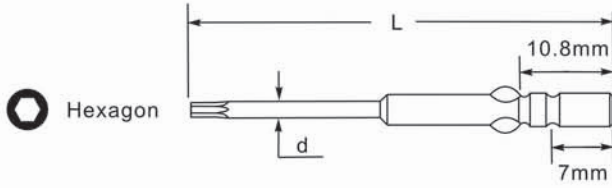

Order No.	Size mm	d mm	L mm
74091540	1.5	2.0	40
74091560	1.5	2.5	60
74092040	2.0	3.0	40
74092060	2.0	3.0	60
74092540	2.5	3.5	40
74092560	2.5	3.5	60
74093040	3.0	3.5	40
74093060	3.0	3.5	60



## ▶ 内星型起子头 Torx Bits

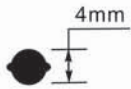

单头4mm, 材质S2 磁性  
Single tip 4mm Material: S2 Magnetic

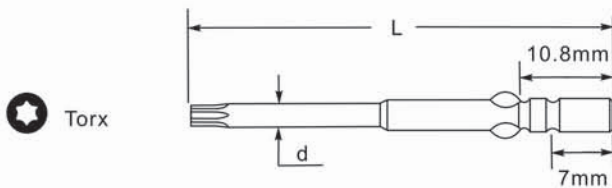

Order No.	T	d mm	L mm
7411T01040	T1	1.7	40
7411T02040	T2	2.0	40
7411T03040	T3	2.0	40
7411T04040	T4	2.0	40
7411T04060	T4	2.0	60
7411T05040	T5	2.0	40
7411T05060	T5	2.0	60
7411T06040	T6	2.0	40
7411T06060	T6	2.0	60
7411T07040	T7	3.0	40
7411T07060	T7	3.0	60
7411T08040	T8	3.0	40
7411T08060	T8	3.0	60
7411T10040	T10	-	40
7411T10060	T10	-	60





## 十字起子头

### Shank Drive Bits

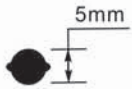

单头5mm, 材质S2 磁性  
Single tip 5mm Material: S2 Magnetic



Phillips

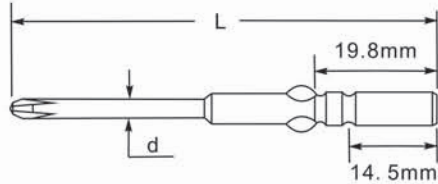

### Order No.

### 头部规格

### d

### L mm

7503PH015060	PH0	1.5	60
7503PH020050	PH0	2.0	50
7503PH020060	PH0	2.0	60
7503PH025060	PH0	2.5	60
7503PH030060	PH0	3.0	60
7503PH120050	PH1	2.0	50
7503PH120060	PH1	2.0	60
7503PH125100	PH1	2.5	100
7503PH130050	PH1	3.0	50
7503PH130060	PH1	3.0	60
7503PH130080	PH1	3.0	80
7503PH130100	PH1	3.0	100
7503PH130120	PH1	3.0	120
7503PH140060	PH1	4.0	60
7503PH140080	PH1	4.0	80
7503PH140100	PH1	4.0	100
7503PH140120	PH1	4.0	120
7503PH150150	PH1	5.0	150
7503PH150200	PH1	5.0	200
7503PH240050	PH2	4.0	50
7503PH240060	PH2	4.0	60
7503PH250080	PH2	5.0	80
7503PH250100	PH2	5.0	100
7503PH250120	PH2	5.0	120
7503PH250150	PH2	5.0	150
7503PH250200	PH2	5.0	200

## 一字起子头

### Shank Drive Bits

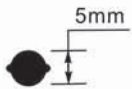

单头5mm, 材质S2 磁性  
Single tip 5mm Material: S2 Magnetic



Slotted

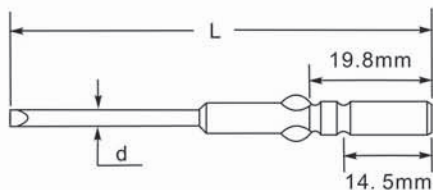

### Order No.

### 头部规格

### d mm

### L mm

75062060	SL2.0	2.0	60
75062560	SL2.5	2.5	60
75063060	SL3.0	3.0	60
75063560	SL3.5	3.5	60
75064060	SL4.0	4.0	60
75065060	SL5.0	5.0	60

1/4"

P1-10

3/8"

P11-44

1/2"

P45-92

5/8"

P93-94

3/4"

P95-112

1"

P113-128

1-1/2"

P129-132

2-1/2"

P133-136

起子套筒

P137-145

起子头

P146-164



# NORMECO INDUSTRIAL BITS

- 1/4"
- P1-10
- 3/8"
- P11-44
- 1/2"
- P45-92
- 5/8"
- P93-94
- 3/4"
- P95-112
- 1"
- P113-128
- 1-1/2"
- P129-132
- 2-1/2"
- P133-136
- 起子套筒
- P137-145
- P146-164

## ▶ 内六角起子头 Hex Bits

5mm  
 单头5mm, 材质S2 磁性  
 Single tip 5mm Material: S2 Magnetic

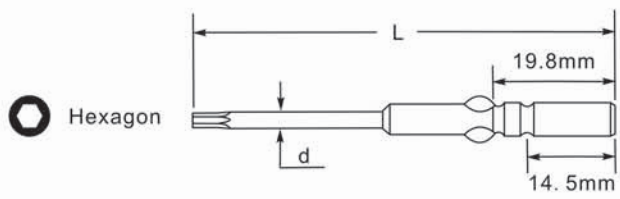
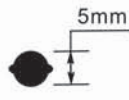

Order No.	Size mm	d mm	L mm
75091560	1.5	2.5	60
75092060	2	2.5	60
75092560	2.5	3.0	60
75093060	3	3.5	60
75094060	4	-	60
75095060	5	-	60



## ▶ 内星型起子头 Torx Bits

5mm  
 单头5mm, 材质S2 磁性  
 Single tip 5mm Material: S2 Magnetic

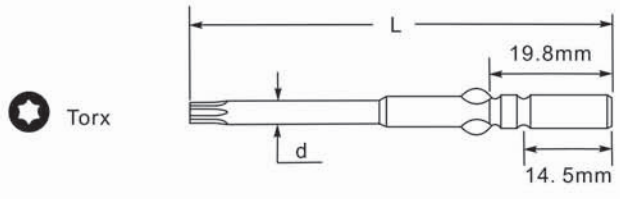
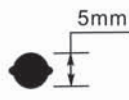

Order No.	T	d mm	L mm
7511T04060	T4	2.0	60
7511T05060	T5	2.5	60
7511T05080	T5	2.5	80
7511T06060	T6	2.5	60
7511T06100	T6	-	100
7511T08060	T8	3.0	60
7511T08080	T8	3.0	80
7511T08100	T8	-	100
7511T08150	T8	-	150
7511T10060	T10	3.0	60
7511T10080	T10	3.0	80
7511T10100	T10	-	100
7511T10150	T10	-	150
7511T15060	T15	3.5	60
7511T15080	T15	3.5	80
7511T15100	T15	-	100
7511T15150	T15	-	150
7511T20060	T20	-	60
7511T20080	T20	-	80
7511T20100	T20	-	100
7511T20150	T20	-	150





## ▶ 内星型起子头

### Torx Bits-Tamper proof

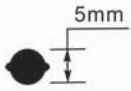

单头5mm, 材质S2 磁性  
Single tip 5mm Material: S2 Magnetic

Order No.	T	d mm	L mm
7513T06060	T6	2.0	60
7513T08060	T8	3.0	60
7513T08100	T8	-	100
7513T10060	T10	-	60
7513T10100	T10	-	100
7513T15060	T15	-	60
7513T15100	T15	-	100
7513T20100	T20	-	100



Torx Tamper Proof

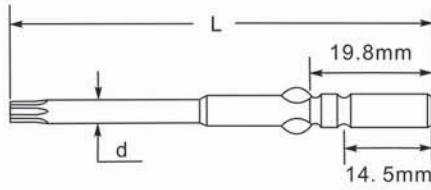

1/4"



P11-10



3/8"



P11-44



1/2"



P45-92



5/8"



P93-94



3/4"



P95-112



1"



P113-128



1-1/2"



P129-132



2-1/2"



P133-136



起子套筒



P137-145



起子头



P146-164



# NORMECO INDUSTRIAL BITS

- 1/4" P1-10
- 3/8" P11-44
- 1/2" P45-92
- 5/8" P93-94
- 3/4" P95-112
- 1" P113-128
- 1-1/2" P129-132
- 2-1/2" P133-136
- 起子套筒 P137-145
- P146-164

## ▶ 十字起子头

### Shank Drive Bits

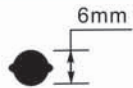

单头6mm, 材质S2 磁性  
Single tip 6mm Material: S2 Magnetic

Order No.	头部规格	d	L mm
7603PH025060	PH0	2.5	60
7603PH125060	PH1	2.5	60
7603PH130060	PH1	3.0	60
7603PH130100	PH1	3.0	100
7603PH135060	PH1	3.5	60
7603PH140060	PH1	4.0	60
7603PH230060	PH2	3.0	60
7603PH240060	PH2	4.0	60
7603PH240100	PH2	4.0	100
7603PH250060	PH2	5.0	60
7603PH250100	PH2	5.0	100
7603PH260120	PH2	-	120
7603PH260150	PH2	-	150

⊕ Phillips

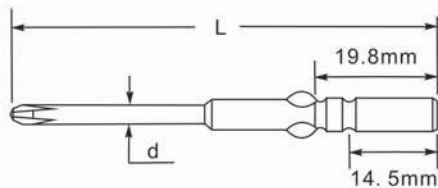

## ▶ 内六角起子头

### Hex Bits

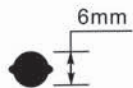

单头6mm, 材质S2 磁性  
Single tip 6mm Material: S2 Magnetic

Order No.	Size mm	d mm	L mm
76092060	2	2.5	60
76093060	3	3.5	60
76094060	4	4.5	60
76095060	5	-	60

⊙ Hexagon

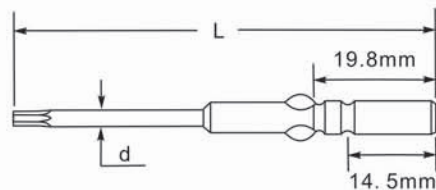



## ▶ 内星型起子头 Torx Bits

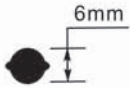

单头6mm, 材质S2 磁性  
Single tip 6mm Material: S2 Magnetic

Order No.	T	d mm	L mm
7611T08060	T8	-	60
7611T10060	T10	-	60
7611T15060	T15	-	60

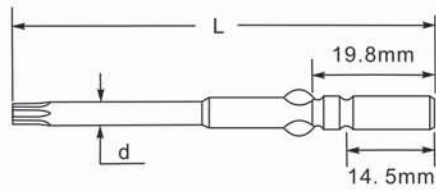

## ▶ 增磁圈 Magnet-plus ring

### Magnet-plus ring

增磁圈能使套筒或起子头磁力瞬间增强, 防止装配作业时螺钉脱落, 可按需定制。适用于头部外径 $<7.2\text{mm}$ 的各类套筒或起子头, 订购前需先向诺麦柯供应商说明配合使用的套筒或起子头规格。

Magnetic force could be enhanced instantly to prevent the screw from falling off when the assembly job is performed with Normeco magnet-plus ring. Standard range is recommended to work with impact bits heads outer dia less than  $7.2\text{mm}$ . Magnet-plus ring for special bits heads sizes are also available on request.

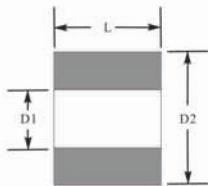

PAT. ZL 2020 2 1756455.3



1/4"



P1-10



3/8"



P11-44



1/2"



P45-92



5/8"



P93-94



3/4"



P95-112



1"



P113-128



1-1/2"



P129-132



2-1/2"



P133-136



起子套筒



P137-145



起子头



P146-164



# NORMECO INDUSTRIAL SOCKETS

 1/4" P1-10					
 3/8" P11-44					
 1/2" P45-92					
 5/8" P93-94					
 3/4" P95-112					
 1" P113-128					
 1-1/2" P129-132					
 2-1/2" P133-136					
 起子套筒 P137-145					
 起子头 P146-164					



工具改变生活  
品质成就未来

Tools Make Life Better, Quality Creates The Future.



工业装配级套筒制造  
*We make industrial sockets*



Normeco Business WhatsApp: +86 17723566838